

Uniden®

**BC 796D APCO 25
DIGITAL SCANNER**



OWNER'S MANUAL

Contents

The FCC Wants You To Know	1
Scanning Legally	2
Introduction	3
Using this Manual	5
Understanding Scanning	6
Conventional Scanning	6
Simplex Operation	6
Repeater Operation	6
Trunked Scanning	7
Motorola Trunking	7
EDACS Trunking	8
LTR Trunking	9
Understanding Banks and Channels	9
Getting More Information	10
Front and Rear View	11
Display Icons	12
Included With Your Scanner	13
Setting Up Your Scanner	14
Connecting an Antenna	14
Mounting an Antenna	14
Optional Antenna	14
Typical Mounting Methods	15
Mounting the Scanner in Your Vehicle	15
Applying Power for Vehicle Installation	16
Desktop Installation	17
Applying Power Using Standard AC Power	17
Connecting an External Speaker	17
Connecting an Earphone	17
Listening Safely	18
Connecting the Clone Cable	18
Connecting the Tape Recorder	18
Basic Operation	19
Turning On the Scanner	19
Setting the Squelch	19
Using the Menu	20
Manually Selecting a Channel	20
Scanning Programmed Channels	20
Locking/Unlocking Banks	20
Locking/Unlocking Channels	21
Restoring All Locked Out Channels	21
Priority Scanning	21
Priority Plus Scanning	21
Listening to the Input Channel	21
Dimmer Light Setting	22
Controlling How Much Information Appears	22
Turning the Key Beep On/Off	22
Locking the ENTER key	22
Disabling the APCO25 Card	23
Muting All Audio	23
Setting Squelch Mode	23
Trunk Scanning Options	23
Searching for Active Talkgroups (ID Search)	23
Scanning Only Stored Talkgroups (ID Scan)	24
Monitoring Talkgroup ID's	24

Selecting Talkgroup Lists to Scan	24
Holding on a Single Talkgroup	24
Locking Out Talkgroups	24
EDACS Blockout	25
Unlocking All Talkgroups	25
EDACS Patch Tracking	25
Searching	26
Holding on an Active Frequency	26
Setting Chain Search	26
Setting Data Skip	26
Skipping Frequencies	26
Storing Found Frequencies	27
Automatically Storing Frequencies	27
Setting Subaudible Tones for Searching	28
Searching for Subaudible Tones	28
Attenuating All Search Ranges	28
Setting DELAY for All Search Ranges	28
Setting a Search Range	29
Searching for Trunk Systems	29
Service Search	31
Service Search Skip	31
Using Weather Search and Weather Alert (SAME)	32
Searching for a Weather Broadcast	32
Using Weather Alert (SAME)	32
Testing the Weather Alert	33
Programming Bank Information	34
Bank Configuration	34
Assigning Bank Names	34
General Programming	35
Deleting Frequencies from Channels	35
Transferring Channel Information	35
Entering Alpha Information	35
General Programming Tips	35
Programming Conventional Channels	37
1. Select a Channel to Program	37
2. Enter the Frequency	37
3. Assigning a Text Tag	37
Setting the Delay	38
Setting the Subaudible Tone Option	38
Setting Beep Alert	39
Setting the Attenuator	39
Changing the Frequency Step	39
Setting the Modulation Mode	40
Setting Priority Channels	40
Programming Trunked Systems	41
Setting Trunking Delay	42
Using I-Call (Motorola and EDACS only)	42
Turning I-Call On and Off for ID Search	42
Turning I-Call On for ID Scan	42
Setting Priority Talkgroups (Motorola and EDACS only)	43
Multi-Track	43
Multi-Track Operational Details	43
Programming Motorola Systems	45
Using Control Channel Programming	45
Programming Type 2/Digital 800 and 900 MHz Systems	45
Programming Type2/Digital VHF and UHF Systems	46
Programming Type I and III Hybrid Systems	47

Toggling the Status Bit	48
Toggling End Code Detect	48
Programming EDACS Systems	49
Programming EDACS Channels	49
Setting EDACS Emergency Alert	49
Setting EDACS Decimal Mode	50
Programming APCO 25 Systems	51
Setting APCO 25 Sound Quality	51
Programming LTR Systems	52
Programming Talkgroups	53
Storing Known Talkgroups	53
Storing Found Talkgroups	53
Deleting Stored Talkgroup ID's	54
Adding a Text Tag to an ID List	54
Seeing Talkgroup Activity	54
Using the Remote Interface	55
PC Control Mode	55
Cloning Scanner Settings	55
Care and Maintenance	57
General Use	57
Location	57
Cleaning	57
Repairs	57
Birdies	57
Troubleshooting.....	58
Specifications	60
Glossary of Terms	61
Appendix	64
One Year Limited Warranty	74

The FCC Wants You To Know

This scanner has been tested and found to comply with the limits for a scanning receiver, pursuant to Part 15 of FCC rules. These limits are designed to provide reasonable protection against harmful interference in a residential installation. This scanner generates, uses, and can radiate radio frequency energy and, if not installed and used in accordance with the instructions, may cause harmful interference to radio communications.

However, there is no guarantee that interference will not occur in a particular installation. If this scanner does cause harmful interference to radio or television reception, which can be determined by turning the scanner on and off, you are encouraged to try to correct the interference by one or more of the following measures:

- Reorient or relocate the receiving antenna
- Increase the separation between the scanner and the receiver

This device complies with Part 15 of FCC rules. Operation is subject to the following two conditions: 1) This device may not cause harmful interference, and 2) this device must accept any interference received, including interference that may cause undesired operation.

Scanning Legally

Your scanner covers frequencies used by many different groups, including police and fire departments, ambulance services, government agencies, private companies, amateur radio services, military operations, pager services, and wire line (telephone and telegraph) service providers. It is legal to listen to almost every transmission your scanner can receive. However, there are some transmissions that you should never intentionally listen to. These include:

- Telephone conversations (cellular, cordless, or other private means of telephone signal transmission)
- Pager transmissions
- Any scrambled or encrypted transmissions

According to the Electronic Communications Privacy Act (ECPA), you are subject to fines and possible imprisonment for intentionally listening to, using, or divulging the contents of such a conversation unless you have the consent of a party to the conversation (unless such activity is otherwise illegal).

This scanner has been designed to prevent the reception of cellular telephone transmissions and the decoding of scrambled transmissions. This is done to comply with the legal requirement that scanners be manufactured so they are not easy to modify to pick up these transmissions. Do not open your scanner's case to make any modifications that could allow it to pick up transmissions that are illegal to monitor. Modifying or tampering with your scanner's internal components or using it in a way other than as described in this manual could invalidate your warranty and void your FCC authorization to operate it.

In some areas, mobile use of this scanner is unlawful or requires a permit. Check the laws in your area. It is also illegal in many areas (and a bad idea everywhere) to interfere with the duties of public safety officials by traveling to the scene of an incident without authorization.

Uniden® and Bearcat® are registered trademarks of Uniden America Corporation.

TrunkTracker is a proprietary trademark of Uniden America Corporation.

Other trademarks used throughout this manual are the property of their respective holders.

Introduction

The BC796D APCO 25 Digital Trunking Scanner connects you to the exciting world of scanning. Capable of scanning conventional frequencies, analog trunking systems, and the most popular digital trunking systems, it is a great all-in-one solution to your scanning needs.

Here is a brief list of some of the systems you can monitor with your BC796D:

- Motorola Type I, II, III Hybrid, and APCO 25 Phase 1 Digital Systems (including 3600 bps and 9600 bps control channel systems) EDACS and EDACS SCAT trunking systems used by police, fire, ambulance, and other local and state public safety agencies as well as utilities and other businesses.
- LTR trunking systems used by local businesses and a few public safety agencies.
- Conventional Digital APCO 25 frequencies
- CB, GMRS, FRS, Marine, and other 2-way radios used by families, truckers, and community groups
- Business Band frequencies used nationwide
- Amateur Radio frequencies used by licensed radio operators to report emergency weather conditions, experiment with new communications methods, or just to chat.
- Local and national government agencies
- Civil and military aircraft
- FM and TV Broadcast channels
- NOAA Weather Radio
- And much, much more!

The table below lists the frequency ranges, the default mode (AM, FM, or Wideband FM), and the default frequency step for each range.

Frequency Range	Mode (MHz)	Step (kHz)	Frequency Range	Mode (MHz)	Step (kHz)
25.0000 - 27.9950	AM	5	174.0000 - 215.9500	WFM	50
28.0000 - 53.9900	FM	10	216.0000 - 224.9950	FM	5
54.0000 - 71.9500	WFM	50	225.0000 - 399.9500	AM	50
72.0000 - 75.9950	FM	5	400.0000 - 512.0000	NFM	12.5
76.0000 - 87.9500	WFM	50	806.0000 - 823.9875	NFM	12.5
88.0000 - 107.9000	WFM	100	849.0125 - 868.9875	NFM	12.5
108.0000 - 136.9750	AM	25	894.0125 - 956.0000	NFM	12.5
137.0000 - 161.9950	FM	5	1240.0000 - 1300.0000	NFM	12.5
162.0000 - 173.9875	FM	12.5			

In addition, here are a few more of the many features your scanner has. To get the most from your scanner, be sure to review this entire manual.

- **APCO Project 25 Phase 1 Compatible** – works on the latest 9600 bps systems, including systems that use C4FM and CQPSK modulation.*
- **Four-line, 16-character, Alpha Display** – makes it easy for you to see who is talking by displaying the assigned text tag instead of just a frequency or talkgroup ID number.
- **Automatic Digital Detect** – allows the scanner to switch to digital voice decoding when it detects valid APCO 25 data without any special programming.
- **1000 Channels** – lets you store frequencies in 10 banks of 100 channels each.
- **1000 Talkgroup ID's** – lets you store 10 groups of 10 ID's each per bank.
- **Multi-System Tracking** – scans conventional and trunking systems at the same time.
- **Included PC Programming Software and Cable** – makes programming your scanner much easier. Full-featured software included (no registration needed).
- **10 Priority Channels** – switches to the channel you assign as priority if there is activity, so you won't miss a thing.
- **Priority Talkgroups** – increases the priority of selected talkgroups so the scanner is more likely to switch to them if there is activity.
- **Priority Plus Scanning** – lets you scan only those channels you have selected as priority channels.
- **CTCSS and DCS Squelch Modes** – prevents interference from stations not using the mode you select; search mode displays the CTCSS or DCS tone being used by the received station.
- **Preprogrammed Service Search** – makes it easy to find interesting frequencies used by public safety, news media, TV broadcast, weather, amateur radio, FRS, GMRS, special low power, railroad, aircraft, marine, and racing services.
- **Data Skip** – automatically skips frequencies that have a constant-level transmission such as used on data channels for some systems, paging systems, and internally generated birdies.
- **SAME Weather Alert with FIPS** – lets you set your scanner to listen for a SAME event code from the local weather service; sounds an alert and displays the text description for any alert received. FIPS programming lets you restrict the alerts to one county.
- **Turbo Search** – searches for activity on frequencies at up to 300 steps per second (in the 5 kHz step ranges).
- **Scanner Clone Mode** – lets you connect your scanner directly to another scanner to clone all channels and settings.

***Note:** Performance on digital systems can vary due to signal quality, multipath interference, and cellular interference. Unlike analog trunking, where you can hear the audio with some interference mixed in, interference in a digital system completely blocks the signal. If you do not get good digital reception, try adjusting your location or your antenna until reception improves.

Using this Manual

To get the most from this manual, review the contents to become familiar with the basic functions available. If you are new to scanning or trunktracking, be sure to read the “Understanding Scanning” section for a quick background on the technology behind the hobby.

The first thing you’ll need to do is plug the AC charger into the scanner. See “Setting Up Your Scanner” if you need any help doing this.

Next, you’ll want to listen to see what you can hear with your scanner. Install the antenna, then press **SRVC** and use the scroll bar to select TV Broadcast. Assuming you are in an area with a strong enough TV broadcast, your scanner should soon stop on a station’s audio program. Listen to this, or try searching another service for something more interesting, while you review the rest of the manual.

Understanding Scanning

This section provides you with the background on how scanning works. You don't really need to know all of this to use your scanner, but some background knowledge will help you to get the most from your BC796D.

Conventional Scanning

Conventional scanning is a relatively simple concept. Each group of users in a conventional system is assigned a single frequency (for simplex systems) or two frequencies (for repeater systems) to use. Any time one of them transmits, their transmission always goes out on the same frequency. Up until the late 1980's this was the primary way that radio systems operated. Even today, there are a lot of 2-way radio users who operate using a conventional system:

- Aircraft
- Amateur Radio
- FRS/GMRS Users
- Broadcast AM/FM/TV Stations
- Many Business Radio users

When you want to store a conventional system, all you need to know is the frequency they operate on.

When you are scanning a conventional system, the scanner stops very briefly on each channel to see if there is activity. If there isn't, the scanner quickly moves to the next channel. If there is, then the scanner pauses on the transmission until it is over.

Simplex Operation

Simplex systems use a single frequency for both transmit and receive. Most radios using this type of operation are limited to line-of-sight operation. This type of radio is frequently used at construction job sites, and with inexpensive consumer radios such as GMRS/FRS radios. The range is typically 1-5 miles, depending upon the terrain and many other factors.

Repeater Operation

Repeater systems use two frequencies: one transmits from the radio to a central repeater; the other transmits from the repeater to other radios in the system. With a repeater based system, the repeater is located on top of a tall building or on a radio tower that provides great visibility to the area of operation. When a user transmits (on an *input frequency*), the signal is picked up by the repeater and retransmitted (on an *output frequency*). The user's radios always listen for activity on the output frequency and transmit on the input frequency.

Since the repeater is located very high, there is a very large line of sight. Typical repeater systems provide coverage out to about a 25 mile radius from the repeater location.

Trunked Scanning

While conventional scanning worked great while there were only a few groups wanting to use the frequencies, with the advent of smaller, lower-cost radios more and more agencies and businesses wanted to take advantage of the utility of 2-way radio. As a result, the bands that were used most became full, so new users were not able to take advantage of the technology as quickly as they wanted.

Trunking solved this frequency shortage by allowing multiple groups to use the same set of frequencies in a very efficient way. While each type of trunking system operates a little differently (see the next few sections), they all work on the same basic premise: even in a system with a lot of users, only a few users are ever transmitting at any one time.

Instead of being assigned a frequency, as with conventional systems, each group is assigned a Talkgroup ID. A central computer controls the frequency each group operates on...and this frequency selection is made each time a user transmits. So, while on a conventional system queries, replies, and follow-ups are all on a single frequency, they could each be on completely different frequencies on a trunked system. This semi-random frequency assignment made monitoring such a system impossible prior to Uniden's invention of the Trunktracking scanner.

Motorola Trunking

While there are 4 different types of Motorola trunking systems, they all use the same basic trunking method. The system consists of one control channel plus one or more voice channels (typically 10, 20, or 30 total channels). When a user presses Push To Talk (**PTT**) to transmit, their radio first sends their talkgroup information to the control channel. The computer then assigns that talkgroup to a specific voice channel and transmits that data over the control channel. All radios in that talkgroup switch over to the assigned voice channel and the user can begin speaking. This all typically takes place in about a second...the person transmitting hears a beep from their radio when the channel is assigned and it is OK to start talking.

The four systems in use are:

- **Motorola Type I** – the radios send the radio ID, the fleet and subfleet talkgroup ID to the control channel each time they transmit. To program a Type I system, you need to know the system's fleet map. The most common fleet maps are included at the back of this manual. You can also find fleet map resources on the web.
- **Motorola Type II** – the radios only send the radio ID and radio channel code to the control channel. The central computer keeps a database of radio ID's and which talkgroup is assigned to which channel code for each radio, so with this system the user's radio sends only about 1/3 the data as a Type I system with each transmission. Type II systems do not use Fleet-subfleet talkgroups; instead they use a 5-digit ID for each talkgroup.
- **Type Ili Hybrid** — these systems support a mix of both Type I and Type II users. Like Type I systems, you must know the system's fleetmap to ensure proper tracking.
- **Motorola Astro Digital** — for channel control purposes, this type of system operates just like a Type II system — although the control channel can be a 3600 bps data rate (for mixed analog/digital systems) or a 9600 bps (for digital-only systems). Pure digital systems can be implemented under APCO 25 Phase 1 or Phase 2 standards. Your BC796D is able to decode all unencrypted digitized voice traffic on either mixed mode or digital-only APCO 25 Phase 1 systems.

One big difference you will notice with digital versus analog transmissions, is that with analog systems, you might be able to hear weak signals interspersed with hissing. As you move further away from the system, the interference gradually increases until you are unable to make out the transmission. With digital systems, the cutoff point is much more abrupt. You might have a small area where partial decoding occurs...in which case you will hear partial and garbled audio. However, once the scanner is unable to receive the data well enough to decode it, the audio stops entirely. For the best range, antenna selection and placement is critical. See “Connecting an Antenna” for more information.

EDACS Trunking

EDACS trunking works in much the same way as Motorola trunking with a couple of major differences. In an EDACS system, each frequency used by the system is assigned a Logical Channel Number (LCN) so that less data needs to be transmitted by the control channel. Also, talkgroups are assigned in an Agency-Fleet-Subfleet (AFS) hierarchy. Also, there is one variation of EDACS called SCAT that your BC796D can monitor.

- **Logical Channel Numbers** – each frequency used by the system is assigned an LCN. This information is programmed into each user radio. When a user presses **PTT**, their radio sends their AFS information to the control channel. The computer then assigns that talkgroup to a channel and sends the LCN so that all other radios in that talkgroup will switch to the correct channel. To program an EDACS system in your scanner, you will need to know both the frequencies used by the system and the LCN for each frequency so that you can program the frequencies in LCN order.
- **Agency-Fleet-Subfleet** – talkgroup ID’s for EDACS systems are assigned in a way that makes it easy to see at a glance the affiliation of the user. Each radio is assigned a 2-digit agency identifier from 00 – 15. For example, 01 might be used by the police, 02 by ambulance service, 03 by the fire department, and so on. Each agency is then subdivided up to 16 times to provide fleet identification, and then 8 more times to identify subfleets.

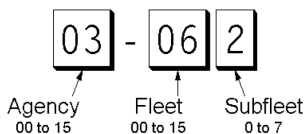

For example, the complete AFS for the Police Department West District’s dispatch channel might be 01-062. 01 identifies the agency as the police department, 06 identifies the fleet as the West district, and 02 identifies the subfleet as the dispatch channel. While these assignments are somewhat arbitrary and vary from system to system, there are many resources on the web for finding the assignments for most systems.

Because of the logical hierarchy of the AFS system, your BC796D lets you assign wildcard ID’s that let you, for example, use only one ID memory to identify all units in either an agency or a fleet.

- **EDACS SCAT** – EDACS SCAT (Single Channel Autonomous Trunking) systems operate on a single channel and alternate control data with analog voice traffic. While your BC796D cannot track ID’s in this system, it can eliminate the control data so that all you hear is the voice transmissions when you monitor this type of system.

LTR Trunking

LTR® (Logic Trunked Radio) systems are trunking systems used primarily by business or private communications service providers, such as taxicabs, delivery trucks, and repair services. These systems encode all control information as digital subaudible data that accompanies each transmission, so there is no separate control channel. Users on an LTR system are assigned to specific talkgroups, which are identified by the radio as six digit numbers. These numbers are in the form AHHUUU, where:

A= Area code (0 or 1)

H= Home repeater (01 through 20)

U= User ID (000 through 254)

When the scanner receives a transmission on a channel set to the LTR mode, it first decodes the LTR data included with the transmission. In the ID Search mode, the scanner stops on the transmission and displays the talkgroup ID on the display. In the ID Scan mode, the scanner only stops on the transmission if the LTR data matches a talkgroup ID that you have stored in the bank's talkgroup ID list and have not locked out.

LTR systems are frequently programmed so that each radio has a unique User ID.

LTR systems also need to be programmed into your scanner in channel-order.

Since many LTR systems use only odd-numbered channel slots, you would program these systems using only the corresponding odd-numbered channels in a bank (for example, you would program a system with channels at 1, 3, 5, and 9 into Trunk 2 channels 101, 103, 105, and 109).

Understanding Banks and Channels

The memory in your scanner is organized into 10 banks of 100 channels each. Each bank can contain conventional channels as well as 1 trunking system. For each trunking system, each bank can also store 10 groups of 10 talkgroup ID's (100 per bank).

Getting More Information

By itself, this manual really only provides part of what you need to know to have fun scanning – how to program and use the scanner. The two supplied Conventional and Trunking frequency guides will give you a good head start on the other part of what you need to know – what frequencies have interesting content. You can also find a wealth of information on the Internet...check out scanners.uniden.com for the latest frequency information in your area.

In addition, you can contact the following source of frequency information:

- Scanner Master
(800) 722-6701 (Hours are from 10:00 a.m. to 5:00 p.m. Eastern Time Monday through Friday.)

To purchase another copy of the conventional or trunking frequency guide, contact one of the following:

- Uniden Parts Department
(800) 554-3988 (Hours are from 8:00 a.m. to 5:00 p.m. Central Time Monday through Friday.)
- Your Local Dealer

Front and Rear View

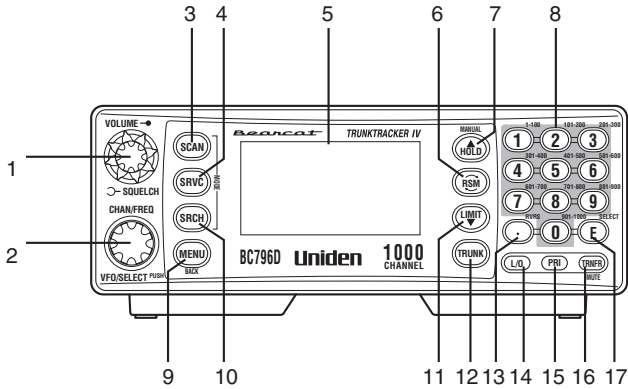



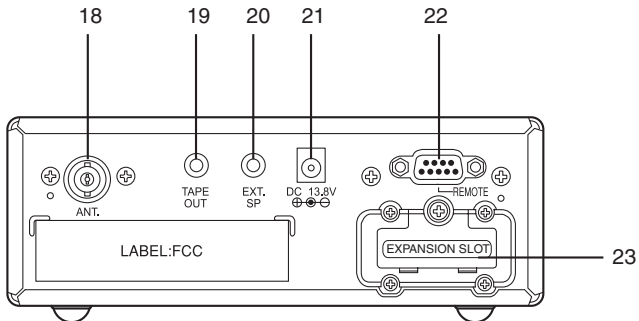

- | | |
|--|--|
| 1. Volume/Squelch Control | 10. Search Key (SRCH) |
| 2. VFO/Select
Channel/Frequency Control | 11. Limit/Down Key (LIMIT ▼) |
| 3. Scan Key (SCAN) | 12. Trunk Key (TRUNK) |
| 4. Service Key (SRVC) | 13. Decimal/Reverse Key
(◌) |
| 5. Display | 14. Lockout Key (L/O) |
| 6. Resume Key (RSM) | 15. Priority Key (PRI) |
| 7. Hold/Up/Manual Key (▲/HOLD) | 16. Transfer/Mute Key (TRNFR) |
| 8. Numeric Keypad | 17. Enter/Select Key (E) |
| 9. Menu/Bank Key (MENU) | |



- | | |
|-------------------------------|-----------------------------|
| 18. Antenna Connector | 20. External Speaker Jack |
| 19. Tape Recorder Output Jack | 21. DC Power Jack |
| | 22. Remote Control Terminal |
| | 23. Expansion Slot |

Display Icons

ICON	DESCRIPTION
	Priority Channel Indicator
	Lock Out Mode Indicator
	Scan/Search Direction Indicator
SRCH	Chain Search Mode Indicator
SRVC	Service Search Mode Indicator
SCAN	Scan Mode Indicator
ID SCAN	ID Scan Mode Indicator
ID SEARCH	ID Search Mode Indicator
C	Channel Type Conventional Type
M	Trunk Type
L	Motorola Tracking Type
E	LTR Tracking Type EDACS Tracking Type
DAT	Control Channel Data
LNK	Voice Channel Data
P25	Digital Communications P25: APCO Project 25
AM,FM WFM,NFM	Receiving Mode Indicators
	Signal Meter

Included With Your Scanner

If any of these items are missing or damaged, immediately contact your place of purchase or Uniden Customer Service at: (800) 297-1023, 8:00 a.m. to 5:00 p.m., Central Time, Monday through Friday.

- BC796D Scanner
- AC Adapter (AD 580D)
- Cigarette Cord
- DC Cord
- Mounting Bracket
- Telescopic Antenna
- Operating Guide
- Trunk Tracker Frequency Guide
- Other Printed Material
- BC796D SS CD-ROM

Setting Up Your Scanner

Connecting an Antenna

You must install an antenna before you can operate the scanner. You have been provided a standard telescopic antenna that works well with this scanner, but you may want to purchase another type to increase the range. To connect the telescopic antenna, simply connect it to the BNC type ANT. connector on the rear of the scanner. You can purchase a variety of scanner antennas for both mobile and base station available at a local electronics store. Choose the one that best meets your needs.

When deciding on a mobile or base station antenna and its location, consider these points.

- The antenna should be as high as possible on a vehicle or a house.
- The antenna and its cable should be as far as possible from sources of electrical noise (ignition systems, gauges, and so on).
- The antenna should be vertical for the best performance.

Mounting an Antenna

Once you choose an antenna, follow the mounting instructions supplied with the antenna. Then route the antenna cable to the scanner.

The antenna connector on your scanner makes it easy to use the scanner with a variety of antennas, such as an external mobile antenna or an outdoor base station antenna.

Always use 50 ohm coaxial cable, such as RG-58 or RG-8, to connect an outdoor antenna. For lengths over 50 feet, use RG-8 low-loss dielectric coaxial cable. If your antenna's cable does not have a BNC connector, you will also need a BNC adapter (available at a local electronics store).

Follow the Installation instructions supplied with the antenna, route the antenna cable to the scanner, then connect it to the **ANT.** jack.

Warning: Use extreme caution when you install or remove an outdoor antenna. If the antenna starts to fall, let it go! It could contact overhead power lines. If the antenna touches a power line, contact with the antenna, mast, cable, or guy wires can cause electrocution and death. Call the power company to remove the antenna. DO NOT attempt to do it yourself.

Optional Antenna

If you have chosen an optional mobile antenna, connect the antenna plug into the **ANT.** connector on the rear of the scanner. (For more information on antenna installation, please refer to the instruction guide that came with your antenna.)

Typical Mounting Methods

The BC796D can be conveniently mounted on a table, bulkhead, overhead, or any other desired location (refer to figure below for typical mounting methods).

Caution: Make sure there are no hidden electrical wires or other items behind the desired location before proceeding. Check that free access for mounting and cabling is available.

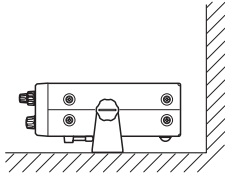

• Table top mount

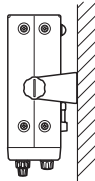

• Bulkhead mount

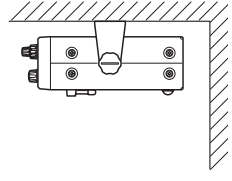

• Overhead mount

Mounting the Scanner in Your Vehicle

Before you mount the scanner, make sure you have all the necessary materials. Then confirm that the scanner fits your vehicle's mounting area. This unit requires a mounting area of 2-3/8 inch high by 6-15/16 inch wide by 6-9/16 inch deep (61 x 176.5 x 167 mm).

Caution: Be sure to avoid obstructions behind the mounting surface.

Follow these steps to mount the scanner in your vehicle.

1. Choose a mounting location, then use the supplied mounting bracket as a template to mark the positions for the mounting screw holes.
2. In the marked positions, drill holes slightly smaller than the supplied screws.
3. Attach the mounting bracket to the mounting location using the supplied screws and lock washers.
4. Attach the scanner to the mounting bracket using the supplied mounting knobs.
5. Connect the antenna's cable to the **ANT.** connector on the back of the scanner.

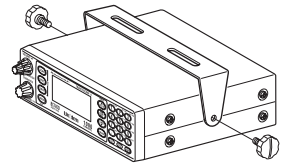
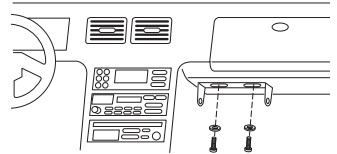

Note: If the antenna cable's connector does not fit in the **ANT.** connector, you might also need a Motorola-to BNC antenna plug adapter (available at a local electronics store).

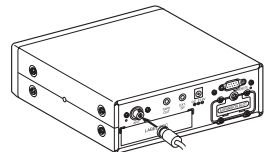

Aplying Power for Vehicle Installation

You can power your scanner using either the supplied DC power cord or your vehicle's cigarette lighter socket using DC cigarette lighter power cord.

Caution: You must use a power source that supplies 13.8 V DC and delivers at least 700 mA. Your standard 12 V car battery should be sufficient. The cord connector's center tip must be set to positive and its plug must fit the scanner's **DC 13.8 V** jack. The supplied DC power cord meets these specifications. Using a power cord that does not meet these specifications could damage the scanner or the adapter.

- Always connect the adapter or DC power cord to the scanner before you connect it to the power source. When you finish, disconnect the adapter or DC power cord from the power source before you disconnect it from the scanner.
- For added safety and to protect your scanner, disconnect the cable from your vehicle battery's negative (-) terminal before you begin.

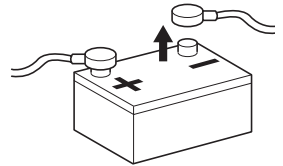

Follow these steps to connect the supplied DC power cord.

1. Connect the power cord's black wire to a chassis ground, such as a metal screw attached to a metal part of the vehicle's frame. Be sure that the screw is not insulated from the frame by a plastic part.
2. Connect the power cord's red wire (with in-line fuse) to a source of voltage that turns on and off with the ignition switch, such as a spare accessory terminal in your vehicle's fuse box.
3. Insert the power cord's barrel plug into the **DC 13.8 V** jack on the back of the scanner.
4. Reconnect the cable to the vehicle battery's negative (-) terminal.

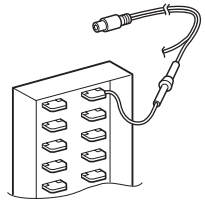

To power the scanner from a vehicle's 12 V power source (such as a cigarette-lighter socket), you need a cigarette-lighter adapter.

To connect an optional DC cigarette-lighter power cable, insert its barrel plug into the **DC 13.8 V** jack on the back of the scanner, then plug the power cable into your vehicle's cigarette lighter socket.

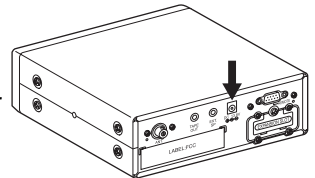

Note: If you use a cigarette-lighter power cable and your vehicle's engine is running, you might hear electrical noise from the engine while scanning. This is normal.

Desktop Installation

You can place this scanner on a desk, shelf, or table to use it as a base station.

1. Flip up the feet for desk installation.
2. Extend the antenna to full vertical position.
Adjust the angle for best reception.

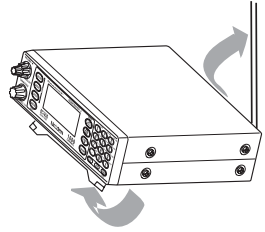

Applying Power Using Standard AC Power

To power the scanner from an AC outlet, use the provided AC adapter with a 5.5 mm outer diameter/2.1mm inner diameter tip.

Caution: You must use a Class 2 power source that supplies 13.8 V DC and delivers at least 700 mA. The cord connector's center tip must be set to positive and its plug must fit the scanner's **DC 13.8 V** jack. Using an adapter that does not meet these specifications could damage the scanner or the adapter.

- Always connect the AC adapter to the scanner before you connect it to AC power. When you finish, disconnect the adapter from the AC power before you disconnect it from the scanner.

1. Insert the adapter's barrel plug into the **DC 13.8 V** jack on the back of the scanner.
2. Plug the adapter into a standard AC outlet.

Note: Use only the AC adapter supplied with your scanner.

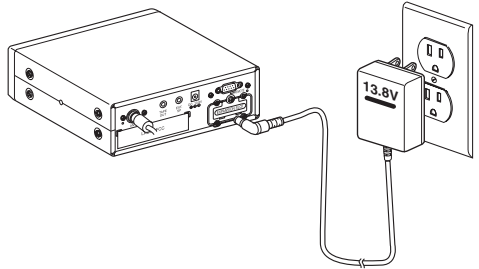

Connecting an External Speaker

In a noisy area, an external speaker (available at a local electronics store) positioned in the right place might provide more comfortable listening.

Plug the speaker cable's 1/8 inch (3.5 mm) plug into your scanner's **EXT. SP.** jack.

Note: Connecting an external speaker disconnects the scanner's internal speaker.

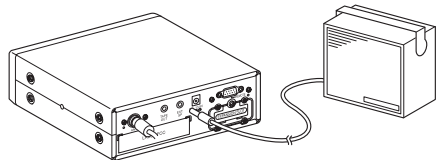

Connecting an Earphone

For private listening, you can connect an earphone with a 1/8 inch (3.5 mm) plug to the **EXT. SP.** jack on the back of the scanner. **Be very careful as damage to your hearing can result if the VOLUME control is not set to the lowest level first.** See below for "Listening Safely" instructions. (Your local electronics store should carry a wide selection of earphones.) Once the earphone is connected, it will automatically disconnects the internal speaker.

Listening Safely

To protect your hearing, follow these guidelines when you use an earphone or headphones.

- **Do not use the earphone to listen to the WX alert siren test or when in SAME Alert mode. The alert tone's volume is not adjustable and damage to your hearing could occur.**
- Do not listen at extremely high volume levels. Extended high volume listening can lead to permanent hearing loss.
- Set the **VOLUME** to the lowest setting before you begin listening. After you begin listening, adjust the **VOLUME** to a comfortable level.
- Once you set the **VOLUME**, do not increase it. Over time, your ears adapt to the volume level, so a volume level that does not cause discomfort might still damage your hearing.

Connecting the Clone Cable

You can transfer the programmed data to and from another BC796D scanner using a RS232C Cable (9 pin to 9 pin) (not supplied). Connect the cable between each scanner's **REMOTE** jacks. See "Clone Mode" on page 73. You can also upload or download the programmed data to or from a PC using an optional PC interface kit available through your local electronics store.

Connecting the Tape Recorder

You can use a standard tape recorder or a VOX (Voice Operated Control) recorder. To connect the recorder to the scanner, connect a cable with a 1/8 inch (3.5 mm) plug from the tape recorder's remote jack to the **TAPE OUT** jack on the back of the scanner. (Your local electronics store should carry a wide selection of cables and tape recorders.)

Remember!

- You must mark a channel, ID, talkgroup, or bank for Recording in order for this feature to work.
- This feature does not work if your scanner is set with **MUTE ON**.

To set the record for the channel.

2*SCAN OPTION → 1*CONVENTIONAL → select the channel number, then press **E**.
→ 8*RECORD → 1*ON

To set the record for the search.

1*SERVICE OPTION → *CHAIN SEARCH → 6*RECORD → 1*ON

To set the record for talkgroup ID.

2*SCAN OPTION → 2*TRUNK → select the bank, then press **E** → 3*TALK GROUP
→ select ID LIST, then press **E** → 3*RECORD → 1*ON

To set the record for ID Searching (see "Searching for Active Talkgroups"),

2*SCAN OPTION → 2*TRUNK → select the bank, then press **E** → 5*RECORD →
1*ON

Basic Operation

This section is your main reference for using the scanner once you have programmed conventional and trunked systems. Note that there are some slight differences to some functions depending on whether you are trying to affect conventional operation or trunked operation. Be sure to refer to the appropriate section depending on the mode you are using.

Turning On the Scanner

Turn the **VOLUME** control clockwise out of the detent position. The scanner automatically starts scanning. Since there are no frequencies programmed in your scanner initially, you may not receive any signals. Once you set the squelch and program some frequencies, you will begin hearing conversations regularly.

Setting the Squelch

To set the squelch, you must be in the hold mode, and you should not be receiving a signal on your scanner.

1. Press **▲/HOLD** until you do not hear a signal.
2. Make sure that the **VOLUME** is set to a comfortable listening level.
3. Think of the Squelch Control as a gate. Turn the **SQUELCH** control fully counterclockwise. This raises the “Squelch Gate” so high that only very strong signals can get through.
4. Turn **SQUELCH** clockwise until you hear a hiss. This lowers the “Squelch Gate” so that everything gets through – noise, weak signals, medium signals and strong signals.
5. Turn **SQUELCH** back counter-clockwise just until the hiss stops. Now the “Squelch Gate” allows only clear signals through.

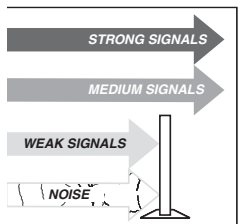
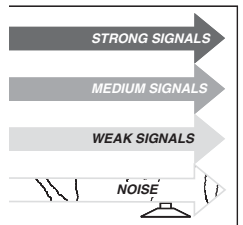
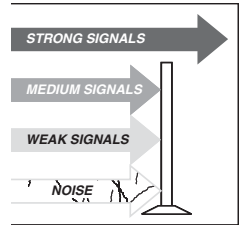

Note: For Trunk Scanning, a good squelch setting is critical. The recommended setting is midpoint. If you set the squelch too high, the scanner might not reliably stop on the control channel.

Using the Menu

Many of your scanner's functions are accessed through its menu system. For complete information about a menu option, see the section referencing its use. A complete list of the menu structure is included in the back of this manual. To select a menu item, first press **MENU** to go to the first-level menu. Then, either press the number key corresponding to the option you want to select, or use the scroll bar to highlight the option then press **E**.

To back up a menu level, press **MENU**.

- Notes:**
- To change a setting that affects either a specific bank or channel, first select a channel within the bank or the channel that you want to modify.
 - To check the settings for a channel, press and hold **MENU** for 2 seconds. In this manual, we represent navigation through the menu with the following notation:
MAIN MENU → SUB MENU 1 → SUB MENU 2
For example to access the DIMMER LIGHT option, the notation is:
3:SYSTEM OPTION → 1:DIMMER
To access this option, press **MENU**, then scroll to each menu option and press **E**. Or, press **MENU**, 3, 1.
 - Some menu items are not numbered. To access these options, you must manually navigate to the selection using the scroll bar.

Manually Selecting a Channel

To manually select a channel, press **▲/HOLD**, the channel number, then **▲/HOLD** again. The scanner displays the information stored in that channel.

- Notes:**
- If the channel contains trunked system information, frequency data is not displayed.
 - If you are trunk scanning, you need to first press **TRUNK** to exit the trunking mode.

Scanning Programmed Channels

Before you can scan, you must first program channels. See the appropriate programming section for complete instructions.

To begin scanning, simply turn on your scanner or, if the scanner is not currently scanning, press **SCAN**. The scanner checks each system you have programmed that is not locked out and stops if there is activity. **SCAN** scrolls across the display, right to left.

When the scanner receives a signal on a programmed channel, it stops on that channel and displays the channel information (text tag, channel number, trunk mode).

Locking/Unlocking Banks

When you are scanning conventional banks, the scanner displays the digit corresponding to all unlocked banks. To lock out a bank so that the scanner does not scan its channels, press the number that corresponds to the bank. The scanner replaces that bank's number with a dash.

To unlock locked-out banks, simply press that bank's number again. The scanner displays that bank's number and includes it when scanning.

Note: You cannot lockout all banks. One bank must be unlocked at all times.

Locking/Unlocking Channels

To lock out a channel so that the scanner does not stop on it while scanning, press **L/O** when the scanner is stopped on that channel or manually select the channel and press **L/O**. To unlock the channel, manually select it and press **L/O** again.

Note: You cannot lockout all channels in a bank. One channel must remain unlocked. If you want to lock out an entire bank, see the previous section.

Restoring All Locked Out Channels

To simultaneously unlock all channels, press **▲/HOLD**, then press and hold **L/O** for 2 seconds. The scanner beeps twice and unlocks all channels.

Priority Scanning

When Priority Scan is turned on, the scanner checks the conventional priority channels in the unlocked banks every 2 seconds or the priority ID's in trunked systems every 4 seconds between transmissions. If a signal is present on a priority channel, the scanner switches to monitor that transmission, even if it had been stopped on another channel. One channel or talkgroup ID in each bank is designated as the priority.

To turn on Priority Scan, repeatedly press **PRI** until the scanner displays PRIORITY ON. To turn Priority Scan off, repeatedly press **PRI** until the scanner displays PRIORITY OFF.

Note: If all priority channels in unlocked banks are locked out, the scanner displays ERROR when you try to turn on the priority scan mode.

Priority Plus Scanning

To scan only the priority channels in the unlocked banks, while scanning repeatedly press **PRI** until the scanner displays PRIORITY PLUS. To turn off Priority Plus, repeatedly press **PRI** to select PRIORITY ON or PRIORITY OFF.

Note: Priority Plus only operates in the scan mode; not in the hold or search mode.

Listening to the Input Channel

Repeater-based systems, such as public safety conventional, trunked systems, and some other business and amateur radio systems, use two sets of frequencies – input frequencies and output frequencies (see “Understanding Scanning”). You normally listen to the output frequency, as it can generally be received from a much farther range. Sometimes, though, you might want to know if the mobile unit is nearby. To do this, check the input frequency by pressing **RVRS**. If you hear the transmission, then the mobile unit is probably within 2 or 3 miles of your location.

Dimmer Light Setting

The Dimmer Light setting sets the brightness of the display backlight.

3:SYSTEM OPTION → 1:DIMMER

1:HIGH

Set the backlight to the brightest setting

2:MEDIUM

Set the backlight to be dimmer

3:OFF

Set the backlight off

Controlling How Much Information Appears

The scanner normally displays trunk, frequency, receiving mode, and a signal meter when it is scanning. This option allows you to reduce how much information your scanner displays.

3:SYSTEM OPTION → 2:SCREEN MASK

1:ON

Display all information

2:OFF

Display reduced information

Turning the Key Beep On/Off

When Key Tone is turned on, the scanner beeps each time you press a key.

3:SYSTEM OPTION → 3:KEY BEEP

1:ON

Turn on the key beep

2:OFF

Turn off the key beep

Locking the ENTER key

To prevent accidentally changing channel settings, you can lock the ENTER key.

3:SYSTEM OPTION → 4:ENTER LOCK

1:ON

The ENTER key is disabled.

2:OFF

The ENTER key operates normally.

Note: The ENTER key operates normally when selecting menu options, even when you set the option to ON.

Disabling the APCO25 Card

If you are not in an area where there is an APCO 25 digital system, you can save power by disabling the APCO 25 (P-25) card.

3:SYSTEM OPTION → 0:P-25 CARD

1:ENABLE

The card is enabled

2:DISABLE

The card is disabled

Muting All Audio

To mute all audio, press and hold MUTE for 2 seconds. The scanner operates normally, but no audio sounds from the scanner. To turn audio back on, press and hold MUTE for 2 seconds.

Setting Squelch Mode

You can set the scanner to either stop on any transmission during searching or scanning, or only stop on transmissions that include a specific CTCSS or DCS subaudible tone (see “Understanding Scanning” for information about subaudible tones).

3:SYSTEM OPTION → 8:SQ MODE

1:CSQ

Carrier Squelch mode; the scanner stops on any transmission regardless of whether a subaudible tone is present.

2:TONE SQ

The scanner stops on transmissions that include a matching subaudible tone or have no tone at all. When you select this option, you also need to set the appropriate tone in either the channel memory or for the search range.

3:TONE SEARCH

When the scanner stops on a transmission, it will then scan the subaudible tones to determine the correct setting. When the scanner has found the correct tone, it flashes the tone on the display. If you store that frequency into a channel, the tone is also stored.

Trunk Scanning Options

When you are scanning a trunked system, there are several trunking-only options available to you. This section outlines these options.

Searching for Active Talkgroups (ID Search)

If you want to hear all activity on a system, use the ID Search mode. While scanning a trunking system, press **SRCH** while scanning that system; or, press and hold **TRUNK** until the scanner flashes **READY TO ID SEARCH**. The BC796D stops on every active talkgroup, regardless of whether you have programmed it into your scanner.

Notes: • If you have not yet programmed any ID’s for the system, this is the only mode available.

- In the ID search mode, the scanner displays the alpha tags associated with the stored talkgroups or NEW for talkgroups you have not stored.

Scanning Only Stored Talkgroups (ID Scan)

To scan only those talkgroups you have stored into your scanner, press **SCAN** while scanning that system; or, press and hold **TRUNK** until the scanner displays **READY TO ID SCAN**. When one of the talkgroups you have stored becomes active, the scanner switches to that transmission and displays the ID number and the alpha tag for that talk group.

Note: You must store at least two talkgroup IDs in the system for ID scanning to work.

Monitoring Talkgroup ID's

To see all of the ID's that are active on the system, while monitoring a trunked system press **TRUNK**. The scanner stops trunking the system and instead holds on the system's control channel. You hear the control data and the scanner displays every talkgroup ID as it becomes active in the system. To resume trunktracking, press **TRUNK** again.

Selecting Talkgroup Lists to Scan

When the scanner is in the ID Scan mode, you can select which ID lists you want the BC796D to scan. First, if you are scanning a Motorola or EDACS system, ensure that you are in the Scan List mode. Press **RVRS** until the scanner displays "List" at the left side of line 3 in the display when it has not stopped on a talkgroup or on the left side of line 4 if it has stopped on a talkgroup. Then, press the number corresponding to the ID list you want to turn on or off.

Holding on a Single Talkgroup

To hold on an active talkgroup when scanning or searching, press **▲/HOLD**. The BC796D stops scanning and holds on the current trunking system. It only receives transmissions on the talkgroup that was active when you pressed **▲/HOLD**

To select a talkgroup to hold on when that talkgroup is not active, you must first program that talkgroup into an ID list. Then, while scanning that system, use the scroll bar to select the talkgroup ID to hold on.

To select a talkgroup to hold on when that group is not active, while ID scanning or ID searching the system, press **▲/HOLD**. Then, either enter the ID or (if you have stored the ID) scroll to the ID you want to hold on.

Locking Out Talkgroups

Like conventional scanning, you can lockout unwanted talkgroup traffic on trunking systems. This is particularly important if you are ID Searching a trunking system, as many systems share both voice traffic (that you usually want to hear) with some data traffic from water meter systems, door alarms, traffic signals and other data sources that you don't want to hear.

To lockout a talkgroup, press **L/O** when the scanner stops on that group. Or, if you have stored the talkgroup in an ID list, select that ID and press **L/O**.

To unlock a talkgroup stored in a scan list, use the scroll bar to manually select that ID, then press **L/O** to unlock it.

To unlock an ID you locked out during ID search or ID scan:

2:SCAN OPTION → 2:TRUNK → Select the Bank → 7:L/O ID REVIEW

Then, use the scroll bar to select the ID you want to unlock and press **L/O**.

Or, press **▲/HOLD** then press **L/O** for 2 seconds to clear all the lockouts from the system.

EDACS Blockout

This is a powerful form of lockout that is only available for EDACS systems. EDACS Blockout lets you lockout entire Agencies or Fleets, not just individual talkgroups. To use blockout, while scanning an EDACS system, press **▲/HOLD** then press **L/O** for 2 seconds to clear all the lockouts from the system. Then enter the agency or the agency and fleet and press **○** then **L/O**. For example, to lockout agency 4, press 04 **○ L/O**.

Unlocking All Talkgroups

To unlock all talkgroups for a system:

2:SCAN OPTION → 2:TRUNK → Select the Bank → 7:L/O ID REVIEW

Then, use the scroll bar to select the ID you want to unlock and press **L/O**.

Or, press **▲/HOLD** then press **L/O** for 2 seconds to clear all the lockouts from the system.

EDACS Patch Tracking

EDACS systems sometimes bring several talkgroups together in a 'Patch'. A patch might be used by a police agency at night to provide a single channel with a single dispatcher for a wide area. A patch is created when a single, temporary talkgroup substitutes for the original talkgroups. While the patch is running, which may be for hours or days, the original talkgroups cease to be used. If you were monitoring one of these talkgroups, you might think there was no traffic, but in fact the talkgroup was operating at the different temporary number.

If a talkgroup in your Scan List is patched, your scanner will continue to receive it under its new identity until the patch has ended. When a patch is being received, the radio will display **PATCH ID**, and will show the temporary common talkgroup plus all the included talkgroups in a cycling display. The BC796D is limited to following one patches. The temporary talkgroups used for patches are usually found in AFS code 15-xxx, and sometimes 00-xxx.

Searching

Your BC796D includes powerful search features that let you discover new active frequencies in your area. You can save up to 10 custom search ranges in your scanner. This section details how to use custom search ranges and also details the various settings that affect search operation.

To start a search, first program one or more search ranges (see “Setting a Search Range”). Then, press **SRCH**. The scanner begins searching within the selected search range. To change to a different search range, press the number button associated with that range.

By default, your scanner only searches one range at a time. To search multiple ranges, turn on Chain Search (see “Setting Chain Search”). When you turn on Chain Search, each time you press a number button, the associated range is turned on or off. Note that you must have at least one range turned on at all times.

Holding on an Active Frequency

To hold on the current frequency, press **▲/HOLD**. To resume searching, press **RSM**.

Setting Chain Search

1:SERVICE OPTION → :CHAIN SEARCH → 1:CHAIN SEARCH

1:ON

The scanner allows you to search multiple ranges simultaneously.

2:OFF

The scanner searches only one range at a time.

Setting Data Skip

The scanner normally stops on any frequency with activity, and remains there until either the activity stops or you press **RSM** or use the scroll bar to resume scanning. However, some signals are identifiable by the scanner as data signals, and you can set the scanner to automatically skip these channels.

3:SYSTEM OPTION → 7:DATA SKIP

1:ON

The scanner skips data frequencies.

2:OFF

Data skip is turned off.

Note: Even with this option turned on, the scanner might pause for a couple of seconds on data transmissions before resuming.

Skipping Frequencies

If a particular frequency continues to interrupt search scanning, it is possible to set your scanner to skip the frequency.

To skip over a frequency, press **L/O** when the scanner is stopped on a frequency you want to skip.

- Notes:**
- You can program up to 200 skip frequencies. The 201st skip frequency entered causes the first skipped frequency to unlock.
 - If all frequencies in the search range are set to skip, a beep sounds and it moves to Search Hold mode. To resume searching:

1) Unskip all skipped frequencies

— OR —

2) Select a different Search Frequency range.

To unskip all skipped frequencies, press and hold **L/O** for 2 seconds in Search Hold mode.

Storing Found Frequencies

If you find a frequency you want to save into a channel, simply press **TRNFR** when the scanner is stopped on that frequency. The scanner displays the lowest-numbered empty channel. Use the scroll bar to select the channel you want to save the frequency into, then press **E**.

- Notes:**
- If you have already stored this frequency, the scanner displays **WARNING DUPLICATE** and the channel where the frequency is stored. To store the frequency anyway, press **E** again.
 - After you store the frequency, the scanner resumes searching.
 - If all channels are used, the scanner defaults to the last-used channel prior to entering the search mode.

Automatically Storing Frequencies

During searching, you can have the scanner automatically store active frequencies into a bank you choose.

```
1:SERVICE OPTION → :CHAIN SEARCH → 7:AUTO STORE →  
1:ON
```

1. Press the numbers corresponding to the banks you want the scanner to store found frequencies into.
2. Press **SRCH** to start the auto-store operation.
3. Press **▲/HOLD** to stop auto-store. The scanner exits the auto-store mode.

Note: To ensure that you catch most active frequencies for the band, you should allow the auto-store operation to continue through at least a few complete sweeps of the band. Depending on the types of services, some occasionally active frequencies might not have activity for minutes or hours at a time.

Setting Subaudible Tones for Searching

You can set the scanner to only stop on transmissions that either have no subaudible tone or include a specified CTCSS or DCS tone during searches. This setting affects all search ranges. For this feature to work, you need to turn on the Tone Mode (see “Setting Squelch Mode”).

1:SERVICE OPTION → :CHAIN SEARCH → 5:TONE DATA

1:CTCSS

Lets you set the CTCSS tone.

2:DCS

Lets you set the DCS.

3:OFF

Does not use subaudible tones.

Note: If, instead of pressing **E** to select a tone you press **L/O**, the scanner will stop on any transmission except for those with the selected tone.

Searching for Subaudible Tones

If you set the system tone option to 3:TONE SEARCH (see “Setting Squelch Mode”), the scanner will determine the correct tone for the received signal.

Attenuating All Search Ranges

If you are near a strong RF source, you might need to attenuate the input signal in order to search properly. To turn on this option for all search ranges:

1:SERVICE OPTION → :CHAIN SEARCH → 4:ATTENUATOR

1:ON

The attenuator is turned on.

2:OFF

The attenuator is turned off.

Setting DELAY for All Search Ranges

You can set the scanner to have a delay after the end of a transmission before searching resumes. This slows searching, but helps you prevent missing replies on a frequency.

1:SERVICE OPTION → :CHAIN SEARCH → 3:DELAY

1:NONE

The delay is turned off.

2:1 SECOND

The delay time is 1 second.

3:2 SECONDS

The delay time is 2 seconds.

4:4 SECONDS

The delay time is 4 seconds.

5: INFINITE

When the scanner stops on a transmission, you must press **RSM** to resume searching.

6: -2 SECONDS

The scanner only stops on transmissions for 2 seconds, then automatically resumes. To hold on the transmission, press **▲/HOLD** during the 2-second pause.

7: -5 SECONDS

The scanner only stops on transmissions for 5 seconds, then automatically resumes. To hold on the transmission, press **▲/HOLD** during the 5-second pause.

8: -10 SECONDS

The scanner only stops on transmissions for 10 seconds, then automatically resumes. To hold on the transmission, press **▲/HOLD** during the 10-second pause.

Setting a Search Range

Before you can use a range search, follow these steps to program at least one of the 10 custom search ranges.

1. Activate the search range mode by using the menu:

1:SERVICE OPTION → :CHAIN SEARCH → 2:SEARCH RANGE
or by pressing and holding **SRCH** for 2 seconds.

2. Use the scroll bar to select the range you want to program, then press **E**.

3. Set the following options:

1: RANGE

Select, then follow the prompts to enter the lower and upper frequency limits for the search range.

2: STEPS

Select, then set the step size to use while searching the custom range. If you select 9: AUTO, the scanner will use the step sizes most often assigned for each band.

3: MODE

Select, then set the modulation mode to use while searching the custom range. If you select 5: AUTO, the scanner will use the modulation mode most often used for each band.

4: ALPHA TAG

Select, then assign an alpha tag to the search range.

5: TRUNK

See "Searching for Trunk Systems."

4. Press **MENU**, then repeat Steps 2 and 3 for additional search ranges.

Searching for Trunk Systems

1:SERVICE OPTION → :CHAIN SEARCH → 2:SEARCH RANGE →
Select the range → 5:TRUNK

This option lets you search for a Motorola trunking control channel within the selected range. To activate this function, select 1:ON, then select an appropriate trunk plan. Most areas use

Plan 1, so this setting should work in most cases.

Note: This feature only works for 800 MHz and 900 MHz Motorola trunking systems.

If the scanner detects a trunking control channel, it will begin to track that system. The scanner displays the talk group numbers as they become active.

Service Search

The Service Search feature lets you scroll through the following twelve preprogrammed services. The frequencies selected for these services are the most commonly used around the U.S.

- 1: WEATHER
- 2: PUBLIC SAFETY
- 3: NEWS
- 4: TV BROADCAST
- 5: HAM RADIO
- 6: MARINE
- 7: RAILROAD
- 8: AIR
- 9: CB RADIO
- 0: FRS & GMRS
- *: RACING
- !: SPECIAL

Note: Special Frequencies are low-power, itinerant, “splinters” and other frequencies which are commonly used at special events and other locations and may or may not be licensed.

To access this feature:

1. Press **SRVC**.

— OR —

Use the menu to select 1: SERVICE OPTION.

2. Select a preprogrammed service to search by selecting from the Service Search menu.

Note: Except for Weather, when you press **E** to select a service, searching begins immediately. For weather search options, see “Using Weather Search and Weather Alert.”

Service Search Skip

You can set the scanner to skip up to 100 unwanted frequencies during Service Search.

To skip over a frequency, press **L/O** when the scanner has stopped at a frequency you want to skip.

To restore a skipped frequency during search, press **▲/HOLD** select the desired frequency using the scroll bar, then press **L/O**.

To restore all skipped frequencies, press and hold **L/O** for 2 seconds.

- Notes:**
- You can not skip frequencies in the Weather Service mode.
 - If you start Service Searching for a service that has all frequencies locked out, you hear a beep and the scanner moves to the Hold mode.

Using Weather Search and Weather Alert (SAME)

Your scanner allows you to either search for a local NOAA weather broadcast, or be set to alert when a SAME weather alert is broadcast on a NOAA channel.

Searching for a Weather Broadcast

To search for a weather broadcast in your area:

```
1:SERVICE OPTION → 1:WEATHER → 1:MONITOR
```

The scanner begins to search the frequencies used by the National Weather Service for these broadcasts. When it finds a broadcast, it stops on the channel until you select another option or reception of the signal stops.

Note: NOAA broadcasts are continuous broadcasts. You will only lose reception if you move out of a coverage area. If the signal is lost, the scanner resumes searching for a weather transmission.

Using Weather Alert (SAME)

Important: Your scanner has been primarily designed to be a radio scanner. While it incorporates weather alert as one feature, we strongly recommend that you not use the scanner as your sole means for receiving emergency alerts. Your local electronics retailer carries several weather radios specifically designed for this function.

SAME (Specific Area Message Encoding) was adopted late in the last century to replace the wide-area alerts previously used. Weather alerts today are preceded by a digital packet that identifies not only the type of alert, but also the geographic location for the alert. Thus, it is possible for a weather broadcast that can be received across many counties to be targeted to a single county.

To specify a county, SAME uses a standard established by the US Census bureau, called FIPS. The format of a FIPS code is:

DSSCCC

Where

D = area subdivision (0=entire area)

SS = State code (00=all states)

CCC = County code (000=all counties)

For example, the FIPS code for Tarrant County, Texas is:

048439 (48=Texas; 439=Tarrant County).

Some counties are further subdivided, in which cases, the first digit will be 0 for all subdivisions in the county and each subdivision will be labeled 1-9.

To program your scanner to alert you when the weather service issues an alert, you must set the scanner to the alert mode, and then leave the scanner monitoring the weather service. You cannot scan and monitor for weather alerts at the same time.

To limit alerts to a specific area, you must also program in the FIPS code(s) for the area(s) you want to receive alerts for. The scanner can be set to either alert for all areas, or only the areas you have programmed. You can get FIPS codes for your area by calling the National Weather Service at 1-888-NWR-SAME or visit their web site at <http://www.nws.noaa.gov/nwr/indexnw.htm>.

To program weather alert operation:

1:SERVICE OPTION → 1:WEATHER → 2:ALERT

1. Select 1:ON to turn on weather alert.
2. Use the scroll bar to select either ALL FIPS or one of the 15 programmable FIPS positions.
3. If you need to program a FIPS code, press **E**, then enter the code and press **E** again.
4. Press **MENU** two times.
5. Select 1:MONITOR.

The scanner displays WX ALERT ON. All audio is muted until an alert is received.

Note: If you lose power or turn off the scanner, the scanner keeps the weather alert mode.

Warning: Never listen to the scanner using a headphone or earphone when you have put the scanner in the weather alert mode. The volume control is disabled in this mode, and the loud alert sound could damage your hearing.

If an event is issued, the scanner displays the text for the event and sounds an alert. The alert sound used depends on the type of event received:

Statements: 2-tone beep

Watches: 2-tone trill

Warnings: Siren

The chart in the back of this manual details the various events and the type of alert produced.

Testing the Weather Alert

To test the alert to see what each alert sounds like, monitor the weather mode, then press **▲/HOLD**. Hold **PRI** for 2 seconds to start the test. Press any key to exit the test. The scanner sounds each of the three alert types repeatedly.

Warning: Never listen to the scanner using a headphone or earphone when you are testing weather alert. The volume control is disabled in this mode, and the loud alert sound could damage your hearing.

Programming Bank Information

In addition to channel and trunking system information you program into each bank (covered in the following sections), this section covers general bank information.

Bank Configuration

Each of your scanner's banks holds 100 channels that can be a mix of conventional (non-trunked) channels and one trunking system. Bank 1 holds Channels 001-100, Bank 2 holds Channels 101-200, and so on through Bank 0 which holds Channels 901-1000.

Additionally, each bank that includes a trunking system can also hold up to 100 Talkgroup ID's for that system.

Assigning Bank Names

To give a bank a name that the scanner displays when it stops on a channel in that bank:

3:SYSTEM OPTION → 9:BANK TAG

1. Use the scroll bar to select the bank you want to tag, then press **E**.
2. Use the scroll bar to select the letter, then press **▲/HOLD** to move the entry position one space to the right or press **LIMIT/▼** to move the entry position one space to the left.
3. When you have entered the tag, press **E** to save the tag and return to Step 1.

General Programming

This section includes procedures that apply regardless of whether you are programming conventional or trunked channels.

Deleting Frequencies from Channels

To delete a stored frequency, manually select the channel, then press **0** and **E**. The contents of the channel are erased.

Transferring Channel Information

To transfer settings from one channel to another:

1. Manually select the channel with the information you want to transfer.
2. Press **TRNFR**. The scanner displays the lowest-numbered empty channel. To select a different channel, use the scroll bar to select the channel.
3. Press **E**. All channel information is stored in the target channel and deleted from the original channel.

Note: Trunking system information is not transferred.

Entering Alpha Information

Your BC796D lets you assign text tags to banks, channels, talkgroups, and search ranges. Follow these steps to enter a text tag.

1. Use the scroll bar to select the letter.
2. Press **▲/HOLD** to advance to the next letter or **LIMIT/▼** to back up to a previous letter.
3. When you have completed the text tag, press **E** to accept the entry.

General Programming Tips

- Do not program weather frequencies into channels. Since they have continuous broadcasts, your scanner will always stop on them. Use weather service search to access NOAA weather broadcasts.
- Group related services into a bank. For example, program city trunk system in Bank 1, amateur radio in Bank 2, and so on.
- To quickly program a series of channels, start with the lowest-numbered channel. The scanner automatically advances to the next channel by default when you complete programming a channel.
- Make a programming plan before you sit down to program your scanner. Write down what frequency you will store in each channel, along with other system information. Or, use the supplied software to organize your information before you start. Keep a record of what you programmed in case you lose programming. This lets you more quickly program the scanner the next time.

- Entered frequencies are rounded off according to the step size for the channel.
- When you store a new frequency in a channel, the text tag previously assigned to that channel is deleted.

Programming Conventional Channels

Each bank can hold a mix of conventional channels plus one trunking system. This section describes how to store known frequencies into conventional channels. The first few sections are intended to be performed in the order indicated if you are entering information the first time. If you are editing existing information, manually select the channel, then use the complete menu process to access the information you want to change.

Note: To quickly store only a frequency in a channel, manually select the channel, enter the frequency, then press **E**. Do not use this method for Trunking systems, however, as these systems require additional information to scan correctly.

1. Select a Channel to Program

To start, first select the channel you want to program:

```
2:SCAN OPTION → 1:CONVENTIONAL
```

Enter the channel number, then press **E**.

2. Enter the Frequency

- Press **1** or highlight **1:FREQUENCY** and press **E**.
- Enter the frequency you want to program, then press **E**.

Notes:

- If the channel already had a frequency programmed, it appears above the prompt.

- If you select a frequency that is not valid, the scanner displays **ERROR OUT OF BAND**. Enter a correct frequency to continue.
- If you enter a frequency that has already been stored in the scanner, the scanner displays **WARNING DUPLICATE** and the channel number that contains the duplicate. To save the frequency anyway, press **E**. Otherwise, press **⏪** to cancel and enter a different frequency.
- If you change an existing frequency, all other information stored for that channel is deleted or set back to default values.

3. Assigning a Text Tag

- Use the scroll bar to select the channel you want to tag, then press **E**.
- Use the scroll bar to select the letter, then press **▲/HOLD** to move the entry position one space to the right or press **LIMIT/▼** to move the entry position one space to the left.
- When you have entered the tag, press **E** to save the tag.

The scanner displays

```
1:OTHER CHANNEL
```

Select to pick another channel to program from Step 1

```
2:CHANNEL OPTION
```

Select to set additional channel options (see the following sections).

3: DONE

Exit the channel setting and menu mode.

Setting the Delay

2: SCAN OPTION → 1: CONVENTIONAL → Channel No. → 2: DELAY

The delay option lets you set a delay after a transmission for each channel. This slows down scanning, but helps to prevent missing replies.

1: NONE

The delay is turned off.

2: 1 SECOND

The delay time is 1 second.

3: 2 SECONDS

The delay time is 2 seconds.

4: 4 SECONDS

The delay time is 4 seconds.

5: INFINITE

When the scanner stops on a transmission, you must press **RSM** to resume searching.

6: -2 SECONDS

The scanner only stops on transmissions for 2 seconds, then automatically resumes. To hold on the transmission, press **▲/HOLD** during the 2-second pause.

7: -5 SECONDS

The scanner only stops on transmissions for 5 seconds, then automatically resumes. To hold on the transmission, press **▲/HOLD** during the 5-second pause.

8: -10 SECONDS

The scanner only stops on transmissions for 10 seconds, then automatically resumes. To hold on the transmission, press **▲/HOLD** during the 10-second pause.

Setting the Subaudible Tone Option

2: SCAN OPTION → 1: CONVENTIONAL → Channel No. → 3: TONE DATA

Some radio systems use special tones to prevent interference from other nearby systems operating on the same frequencies. When tones are being used, the radios only open squelch when a transmission with a matching tone is present on the frequency. Some services, such as FRS, GMRS, and Business Band refer to these tones as Quiet Codes, Privacy Codes, or similar and use a number to associate a particular tone. The table in the back of the manual provides a cross reference to common associations. For this feature to work, you need to turn on the Tone Mode (see “Setting Squelch Mode”).

1: CTCSS

Continuous Tone Coded Squelch System (CTCSS) is used with Amateur Radio, FRS, GMRS, Business Band, and other systems. When you select this option, the scanner only opens squelch when a matching CTCSS tone is present on the frequency.

2: DCS

Digital Coded Squelch is similar to CTCSS, but instead of differentiating codes using frequencies, DCS always uses the same frequency but encodes it with a binary value. When you select this option, the scanner only opens squelch when a matching DCS value is present on the frequency.

3: OFF

The scanner opens squelch regardless of the presence of tones.

Note: If, instead of pressing **E** to select a tone you press **L/O**, the scanner will stop on any transmission except for those with the selected tone.

Setting Beep Alert

2:SCAN OPTION → 1:CONVENTIONAL → Channel No. → 4:BEEP
ALERT

1: ON

The scanner sounds three alert tones when it stops on a transmission on this channel.

2: OFF

Beep Alert is off.

Setting the Attenuator

2:SCAN OPTION → 1:CONVENTIONAL → Channel No. →
5:ATTENUATOR

If you are near a very strong signal source, the signal can overload the scanner's RF front end, causing poor audio quality or missed reception.

1: ON

RF attenuation is on for the channel

2: OFF

RF attenuation is off for the channel

Changing the Frequency Step

2:SCAN OPTION → 1:CONVENTIONAL → Channel No. → 6:STEPS

The channel frequency step option controls the frequency step size used when you manually tune up or down from the frequency stored in the channel. Your BC796D is preprogrammed with the most common steps sizes for each band, so you seldom need to change this setting.

1: 5KHz

Use 5 kHz steps

2: 6.25KHz

Use 6.25 kHz steps

3: 7.5KHz

Use 7.5 kHz steps

4: 10KHz

Use 10 kHz steps

5: 12.5KHz

Use 12.5 kHz steps

6: 25KHz

Use 25 kHz steps

7: 50KHz

Use 50 kHz steps

8: 100KHz

Use 100 kHz steps

9: AUTO

Automatically set the step size based on the band

Setting the Modulation Mode

2:SCAN OPTION → 1:CONVENTIONAL → Channel No. → 7:MODE

Radio transmissions are modulated in several different ways. The BC796D is able to demodulate the most common transmission types. Your scanner has the most common modulation mode preset for each band, so you seldom have to change this option. However there are occasional services that use a modulation mode that is not standard for that band.

1: AM

Amplitude Modulation

2: FM

Frequency Modulation

3: WFM

Wideband FM

4: NFM

Narrowband FM

Setting Priority Channels

You can set one conventional channel in each bank as a priority channel. When you turn on the Priority Scan option (see “Priority Scanning”), the scanner automatically checks these channels every 2 seconds to see if there is activity. If there is, the scanner immediately switches to the priority channel.

- Notes:**
- The scanner does not check priority channels in locked-out banks.
 - The scanner does not check priority channels if the channel is locked out.

By default, the first channel of each bank is set as priority. To change the priority channel:

1. Manually select the channel you want to set as priority.
2. Press and hold **PRI** for 2 seconds. The scanner beeps and the new priority assignment is made.

Note: To program priority talkgroup ID's for trunk scanning, see “Setting Priority Talkgroups.”

Programming Trunked Systems

Your BC796D is designed to scan most major types of trunking systems, including APCO Project 25 Phase 1 digital communication systems. These systems are briefly described here. For a more technical description of each system, see “Understanding Scanning.” General trunking options are also covered in this section. To program the systems, refer to the sections in the manual referenced below

- **APCO Project 25 Phase 1 Systems** — Digital systems that support the APCO Project 25 protocol developed by the Association of Public Safety Communications Officials (APCO), the Telecommunications Industry Association (TIA) and Electronic Industries Alliance (EIA). Systems can operate in conventional, trunked (9600), trunked (3600) and mixed-modes (analog and digital) in any frequency band including UHF, VHF, 800 MHz, and 900 MHz. See “Programming Motorola Systems.”
- **MOTOROLA** – Including Type I, Type II, Hybrid, SMARTNET, and Privacy Plus. Motorola systems are widely used by public safety and business users. Most are on the 800 MHz band, and recent systems are appearing on other bands. See “Programming Motorola Systems.”
- **EDACS** – Including “Wideband” 9600 baud, and “Narrowband” 4800 baud systems. “Wideband” systems are mostly on the 800 MHz band, and are used by public safety, utilities, and business users. Some systems are used on the VHF and UHF bands. “Narrowband” systems are used in the 935-940 MHz band, many by utilities. See “Programming EDACS Systems.”
- **EDACS SCAT** – These systems are mainly used in the Midwestern United States and are one-channel trunking sites using the EDACS format. See “Programming EDACS Systems.”
- **LTR** – These systems are mostly for business users, and found on the UHF, 800 and 900 MHz bands. See “Programming LTR Systems.”

When tracking these types of systems, remember these important points:

- Your scanner defaults to monitor Motorola Type II systems; however, you can change this if the system in your area is different.
- The frequencies for many of the trunked public safety systems are listed in the TrunkTracker National Public Safety Trunked System Frequency Guide included with your BC796D scanner. Frequencies sometimes change, check with scanner.uniden.com for the latest information.

Setting Trunking Delay

Setting a delay for trunking systems helps to ensure that you do not miss replies while scanning.

2:SCAN OPTION → 2:TRUNK → Select the bank → 4:DELAY

1:NONE

The delay is turned off.

2:1 SECOND

The delay time is 1 second.

3:2 SECONDS

The delay time is 2 seconds.

4:4 SECONDS

The delay time is 4 seconds.

5:INFINITE

When the scanner stops on a transmission, you must press **RSM** to resume searching.

6: -2 SECONDS

The scanner only stops on transmissions for 2 seconds, then automatically resumes. To hold on the transmission, press **▲/HOLD** during the 2-second pause.

7: -5 SECONDS

The scanner only stops on transmissions for 5 seconds, then automatically resumes. To hold on the transmission, press **▲/HOLD** during the 5-second pause.

8: -10 SECONDS

The scanner only stops on transmissions for 10 seconds, then automatically resumes. To hold on the transmission, press **▲/HOLD** during the 10-second pause.

Using I-Call (Motorola and EDACS only)

I-Calls are direct unit-to-unit transmissions that are not heard by other users. Your BC796D can monitor these transmissions in either the search mode or (if you have stored the unit number as a talkgroup) in the scan mode.

When the scanner stops on an I-Call, the scanner displays the individual radio unit ID instead of a talkgroup ID.

EDACS or Motorola Type 1 i nnnnn

Motorola Type 2 7 nnnnn

- Note:**
- Each radio in a system has its own unique unit ID. Unit ID's are not published for systems, and since officers might not use the same radio every day, it is difficult to predict who and what you will hear for a specific radio ID.
 - Since a conversation consists of two or more radios, and each radio has its own ID, if you hold on an I-Call, you will only hear one side of the conversation.

Turning I-Call On and Off for ID Search

2:SCAN OPTION → 2:TRUNK → Select the bank → 9:I-CALL

1:ON

The scanner will stop on I-Calls or normal talkgroups.

2: OFF

The scanner ignores I-Calls.

3: ONLY

The scanner only stops on I-Calls.

Turning I-Call On for ID Scan

To receive I-Calls for ID Scan, simply store the radio unit number as () plus the unit number in place of the talkgroup. To receive any I-Call while scanning, enter the I-Call wildcard () 0. For EDACS and Motorola Type 1 systems, this appears as i0; for Motorola Type 2 systems, this appears as 700000.

Setting Priority Talkgroups (Motorola and EDACS only)

Talkgroup priority works slightly different than conventional priority. With talkgroup priority, the priority talkgroups are only checked when the scanner is on the control channel. So, if you have delay turned on for the system or are holding on an ID, the scanner will immediately switch to the priority talkgroup if it becomes active during the delay or while there is no transmission on the held talkgroup.

To assign a talkgroup as the priority talkgroup, select it in Scan Hold mode (see “Holding on a Single Talkgroup”). Then, press and hold **PRI** for 2 seconds.

Multi-Track

The BC796D allows you to track more than one system at a time. Here are some highlights of this feature:

- ❖ You can actually track up to 10 trunking systems at one time.
- ❖ You can trunk, scan, or search and scan conventional frequencies at the same time.
- ❖ You can program conventional frequencies in the same bank as trunking systems. After the scanner finishes checking a trunked system for activity, it will conventionally scan the other frequencies in the bank (remember, only trunking frequencies are programmed in Trunk mode).

To scan a mix of trunking and conventional banks, select the banks you wish to be active, and then press **SCAN**. The scanner will instantly begin scanning. If you have not programmed a trunking bank with talkgroup ID's, you will receive **NO ID (-----)** message for that bank.

You can switch to Search mode and the scanner will search for any active ID's on the system.

Note: To switch ID Scan or ID Search, press and hold **TRUNK** or, press **SCAN** or **SRCH** while scanning.

Multi-Track Operational Details

When more than one trunk system is active (for example two or more trunked systems or a trunked system and one or more conventional frequencies), the radio jumps between systems/frequencies as follows:

TRUNK SCAN: The scanner moves to a trunked system and looks for IDs in your Scan List(s) for up to 1 second. If it finds no activity on your programmed talkgroups, it moves on to conventional channels in the same bank or to the next active bank.

If the scanner finds that a talkgroup in one of your active Scan Lists becomes active, you will begin to hear that communication and the scanner will display the proper talkgroup number and any alpha tag. When the communication ends, the scanner will wait for 2 seconds for any further replies and, if none, the scanner will move to the conventional channels in the same bank or to the next bank. The scanner will not look for any other IDs within the same trunked system (as this would slow the scan process). If you press **RSM** while you are listening to one ID, the scanner will check to see if another ID in your Scan List is active. It will disregard the ID to which you were just monitoring.

TRUNK SEARCH: This mode works similarly to Trunk Scan. If the scanner finds any (non-locked-out) ID when it checks the control channel, you will hear it. You will then hear any replies that follow within 2 seconds. After that the scanner will move on and not continuously search the system for additional IDs (on busy systems you would never leave the system if this were the case). If you press the **RSM** key while monitoring one ID, the radio will check if any other IDs are active (it will disregard the ID you just left), and if none are active, it will move on.

Programming Motorola Systems

Follow the instructions in this section to program information for Motorola Type I, II, III Hybrid, and APCO 25 Digital trunking systems.

Using Control Channel Programming

Your scanner has a powerful feature that lets you program in only the control channels for Motorola 800 and 900 MHz systems. This can greatly shorten the time it takes to program system information.

2:SCAN OPTION → 2:TRUNK → Select the bank → :CNTRL CH ONLY

For 900 MHz systems, you can then simply turn the feature on or off. For 800 MHz systems, you need to select the band plan for the system:

1:PLAN1

Use if the last three digits of **all** of the frequencies used by the system end in 125, 375, 625, or 875.

2:PLAN2

Use if the highest frequency used by the system is above 866 MHz and if the last three digits end in 000, 125, 250, 375, 500, 625, 750, or 875.

3:PLAN3

Use if the last three digits of all the frequencies in the system end in 000, 250, 500, or 750.

4:PLAN4

Use if the highest frequency in the system is below 866 MHz and if the last three digits end in 000, 125, 250, 375, 500, 625, 750, or 875.

5:OFF

Select to turn off control channel programming for this bank.

- Note:**
- Many systems alternate control channels. To properly track the system, you need to program all alternate control channels.
 - If you do not know all of the frequencies for a system, but know at least one control channel, start by selecting Plan 1 (the most common type). If you notice that you seem to be missing transmissions and replies, try each of the other plans until you find the one that works best.

Programming Type 2/Digital 800 and 900 MHz Systems

To program a Type 2/Digital 800 or 900 MHz system, you need to know the frequencies that the system uses.

1. Select the trunk programming mode.

2:SCAN OPTION → 2:TRUNK

2. Use the scroll bar to select the bank you want to program, then press **E**.

1:TRUNK TYPE → 1:ON

3. Select one of the following trunk types for Motorola Type 2 or digital Systems:

1:TYPE2/P25 800

Motorola Type 2 or Digital systems in the 800 MHz band

3:TYPE2/P25 900

Motorola Type 2 or Digital systems in the 900 MHz band

4. Select the channel to store the information into.

2:TRUNK CHANNEL

Use the scroll bar to select a channel within the bank to store a system frequency, then press **E**.

5. Store the channel information

1:FREQUENCY

Enter the frequency for the channel, then enter an Alpha Tag for the channel.

Repeat Steps 4 and 5 to store the rest of the frequencies for the system. Then, see “Programming Talkgroups.”

Programming Type2/Digital VHF and UHF Systems

To program a Type 2/Digital VHF or UHF system, you need to know the frequencies the system uses and also the Base, Space, and Offset settings. These settings are normally provided along with the system frequencies.

1. Select the trunk programming mode.

2:SCAN OPTION → 2:TRUNK

2. Use the scroll bar to select the bank you want to program, then press **E**.

1:TRUNK TYPE → 1:ON

3. Select one of the following trunk types for Motorola Type 2 or digital Systems:

4:TYPE2/P25 UHF

Motorola Type 2 or Digital systems in the UHF (450 – 512 MHz) band

5:TYPE2/P25 VHF

Motorola Type 2 or Digital systems in the VHF (148 – 406 MHz) band

4. Set the Base, Space and Offset settings.

Note: Your BC796D allows you to enter up to three Base, Space, Offset configurations. However, most systems only use one configuration.

- a. Use the scroll bar to select the configuration to program, then press **E**.

BASE CONFIG 1

- b. Enter the system’s base frequency, then press **E**.

- c. Enter the system’s space frequency, then press **E**.

- d. Enter the system’s channel offset, then press **E**.

Repeat a-d or press **MENU** three times to continue programming the system.

5. Select the channel to store the information into.
2:TRUNK CHANNEL
Use the scroll bar to select a channel within the bank to store a system frequency, then press **E**.
6. Store the channel information
1:FREQUENCY
Enter the frequency for the channel, then enter an Alpha Tag for the channel.

Repeat Steps 5 and 6 to store the rest of the frequencies for the system. Then, see "Programming Talkgroups."

Programming Type I and Ili Hybrid Systems

To program a Type I or Ili Hybrid system, you need to know the system's fleet map in addition to the frequency information for the system. Fleet map information is usually provided with the frequencies for the system.

1. Select the trunk programming mode.
2:SCAN OPTION → 2:TRUNK
2. Use the scroll bar to select the bank you want to program, then press **E**.
1:TRUNK TYPE → 1:ON
3. Select the following trunk type for Motorola Type I Systems:
2:TYPE1
Motorola Type I and Ili Hybrid Systems
4. Enter the fleet map information.
Your scanner has the most common fleet maps preprogrammed. Refer to Appendix for a complete list of these fleet maps.
Use the scroll bar to select the preprogrammed fleetmap 1-16 or, if the fleet map does not match a preprogrammed set, select USER CUSTOM. Then, use the scroll bar to select the size code for each block.
5. Select the channel to store the information into.
2:TRUNK CHANNEL
Use the scroll bar to select a channel within the bank to store a system frequency, then press **E**.
6. Store the channel information
1:FREQUENCY
Enter the frequency for the channel, then enter an Alpha Tag for the channel.

Repeat Steps 5 and 6 to store the rest of the frequencies for the system. Then, see "Programming Talkgroups."

Toggleing the Status Bit

Motorola talkgroup ID's are sent as a 16-bit binary number. Normally, the last 4 positions in the number are 0's, which result in all talkgroups being equally divisible by 16. These last four bits, however, can be used by the trunking system to indicate various status conditions. For example, an emergency status could be indicated by setting the second-from last digit to 1. Talkgroup 33264, then would be sent on the system as 33266 when the radio triggered its emergency status. By default, the BC796D ignores the last four digits of every talkgroup, effectively rounding them down to the nearest multiple of 16 regardless of the status bits.

2:SCAN OPTION → 2:TRUNK → Select the bank → 0:STATUS BIT

1:ON

Talkgroups are rounded down to the next multiple of 16.

2:OFF

Talkgroups are not rounded down, so you can determine the value of the status bits.

Toggleing End Code Detect

At the end of each transmission, a digital burst is sent so that radios on the system will quickly switch back to the control channel. Your scanner also listens for this code.

2:SCAN OPTION → 2:TRUNK → Select the bank → #END CODE

1:DETECT

The scanner detects the end code and immediately switches back to the control channel.

2:IGNORE

The scanner waits for the carrier to drop before switching back to the control channel.

Programming EDACS Systems

Follow the instructions in this section to program information for EDACS Wide, EDACS Narrow, and EDACS SCAT trunking systems. Note that to program these systems, in addition to knowing the system type and frequencies used, you must know the logical channel numbers (LCN) for the system's frequencies. This information is usually provided with the frequency and other information. For more information refer to "Understanding Scanning."

Programming EDACS Channels

1. Select the trunk type.

```
2:SCAN OPTION → 2:TRUNK → Select the bank → 1:TRUNK TYPE  
→ 1:ON
```

```
6:EDCS WIDE
```

Select for 9600 baud EDACS systems.

```
7:EDCS NARROW
```

Select for 4800 baud EDACS systems.

```
8:EDCS SCT.
```

Select for EDACS SCAT systems.

2. Program each trunk channel in LCN order (not frequency order). If you program this in the wrong order, the scanner will not go to the correct channel when scanning.

```
2:TRUNK CHANNEL  
ENTER CHANNEL No.
```

- a. Enter the channel to program.

```
1:FREQUENCY
```

- b. Enter the frequency then the alpha tag for the channel

Repeat a and b for each channel in the system.

Note: EDACS SCAT systems use only one channel.

Once you complete channel programming, see "Programming Talkgroups."

Setting EDACS Emergency Alert

When the emergency status is sent on an EDACS radio, you can have your scanner alert you to the transmission.

```
2:SCAN OPTION → 2:TRUNK → Select the bank → 0:EMERGENCY ALT  
1:ON
```

The scanner beeps three times to alert you and flashes EMERGENCY during emergency transmissions.

```
2:OFF
```

The scanner does not handle emergency transmissions any differently than other transmissions.

Setting EDACS Decimal Mode

By default your scanner displays EDACS talkgroups in AFS format (see “Understanding Scanning”). However, you can use this option to display and enter talkgroups in digital format.

2:SCAN OPTION → 2:TRUNK → Select the bank → #EDCS ID FORM

1:AFS

Display the talkgroup ID in Agency-Fleet-Subfleet (AFS) format.

2:DECIMAL

Display the talkgroup ID in decimal format.

Programming APCO 25 Systems

To program an APCO 25 system, follow the steps in the appropriate section for conventional or Motorola Trunking. APCO 25 systems require only 1 additional setting: Sound Quality.

Setting APCO 25 Sound Quality

Each APCO 25 system has slightly different system settings that control how the audio is digitized. To get the best sound quality, you need to match as closely as possible the system's settings.

To adjust the sound quality:

1. While monitoring a specific APCO P-25 talkgroup, press the **▲/HOLD** key.
2. Press and hold the **9** key. On Line 1 of the screen you will see `SOUND QULTY: 0050` (for example). This shows the Sound Quality. The lower the level the better the Sound Quality.
3. To manually set the sound quality, rotate the scroll bar up or down. As the threshold adjusts in increments of 100 at the bottom of the screen watch the Sound Quality level increase or decrease and continue to rotate the **VFO** until you have achieved the best Sound Quality level.

Notes:

- When APCO P-25 signal is not received, `SOUND QULTY: *****` appears on the display.

- You must be receiving an APCO P-25 signal to make this adjustment

A chart showing the Threshold Adjustment Range is listed below.

Band	Lower			Mid	Upper		
	Min	Default	Max	Default	Min	Default	Max
800MHz	33	533	1833	1985	2042	3342	3842
UHF	33	633	1833	1985	2042	3342	3842
VHF	330	930	2130	2147	2264	3464	4064

4. Once you have adjusted the Sound Quality to the best possible level, press **E**.

Press **RSM** to exit the Sound Quality Adjustment Mode.

Notes:

- To cancel the adjusted threshold level, press **○** key.

- The adjusted threshold level for the current frequency can be set back to the default value by pressing and holding the **○** key.
- When you change the Sound Quality it affects all other APCO 25 signals in that same band. (UHF, VHF, or 800MHz).

Programming LTR Systems

Follow the instructions in this section to program information for LTR trunking systems. For more information about LTR systems, refer to “Understanding Scanning.”

2:SCAN OPTION → 2:TRUNK → Enter the bank → 1:TRUNK TYPE →
1:ON → 9:LT → 2:TRUNK CHANNEL

1. Enter the channel number.
1:FREQUENCY
2. Enter the frequency and alpha tag for the channel.
Repeat these steps for all channels in the system. Then, refer to “Programming Talkgroups.”

Note: LTR systems must be programmed in channel order, skipping unused channels. For example, if the LTR system you are programming uses only Channels 1, 3, 5, and 7, program frequencies in the first, third, fifth, and seventh channels in the bank.

Programming Talkgroups

For many of the trunk scanning features to operate, you need to program the scanner with the talkgroup ID's. Each bank can store up to 100 talkgroups in 10 ID groups of 10 talkgroups each. Group similar talkgroups together in the same ID group. When scanning, you can turn ID groups on and off with a quick keypress.

Storing Known Talkgroups

Follow these steps to store talkgroups you have gotten from a list.

2:SCAN OPTION → 2:TRUNK → Select the bank → 3:TALK GROUP

1. Use the scroll bar to select the talkgroup to program, then press **E**.
2. Select 1:ID and press **E**.
3. **For Type 2/Digital systems**, enter the up to 5-digit talkgroup ID, then press **E**.
For Type I systems, enter the 3-digit fleet, **○** for the dash, then the subfleet number.
For EDACS systems, enter the two-digit agency, **○** for the dash, then the fleet and subfleet number.
For LTR systems, enter the area code, **○**, home repeater number, **○**, ID number, then **E**.

Note: If you replace an existing ID, the alpha tag is also deleted.

4. Select 2:ALPHA TAG and press **E**.
5. Enter the alpha tag for the talkgroup.
Note: The alpha tag defaults to the numeric talkgroup ID.
6. If you want the scanner to beep three times to alert you when the talkgroup is active, select 3:BEEP ALERT and press **E**; then, select 1:ON.
7. Press **MENU**.

Repeat this procedure for each talkgroup in the system.

Storing Found Talkgroups

While you are ID Searching (see "Searching for Active Talkgroups"), you can quickly store an active talkgroup ID into an ID memory.

1. While the scanner is receiving the talkgroup, press **▲/HOLD** to hold on that talkgroup.
2. Press **TRNFR**. The scanner displays the lowest numbered empty ID group memory.
3. Use the scroll bar to select the memory you want to store the ID into, then press **E**.

Deleting Stored Talkgroup ID's

To delete a stored talkgroup ID:

1. While scanning a trunked system in the ID scan mode (see “Scanning Only Stored Talkgroups”), press **▲/HOLD**.
Or, to use the menu system:
2:SCAN OPTION → 2:TRUNK → Select the bank → 3:TALK GROUP
2. Use the scroll bar to select the talkgroup ID you want to delete, then press **E**.
3. Select 1:ID and press **E**.
4. Press **0**, then press **E**.

Adding a Text Tag to an ID List

To add a text tag to each of the 10 ID lists in each bank:

2:SCAN OPTION → 2:TRUNK → Select the bank → 6:ID LIST TAG →
Select the list → Enter the alpha tag

Seeing Talkgroup Activity

In the ID Scan mode, the scanner normally only displays the ID for talkgroups that you have stored into a scan list. This setting lets you see the ID's for all talkgroups as they become active when the scanner is monitoring the control channel. The scanner still only switches to a talkgroup if you have stored it into a scan list.

2:SCAN OPTION → 2:TRUNK → Select the bank → 8:ACTIVITY ID

1:ON

Display every talkgroup ID as it becomes active.

2:OFF

Only display active stored talkgroup ID's.

Using the Remote Interface

You can connect your scanner to either a PC or another BC796D using the remote interface cable port. This allows you to either control and program your scanner using a PC and the supplied software and cable or clone the memory from one BC796D into another BC796D (gender changer/coupler required, not supplied).

PC Control Mode

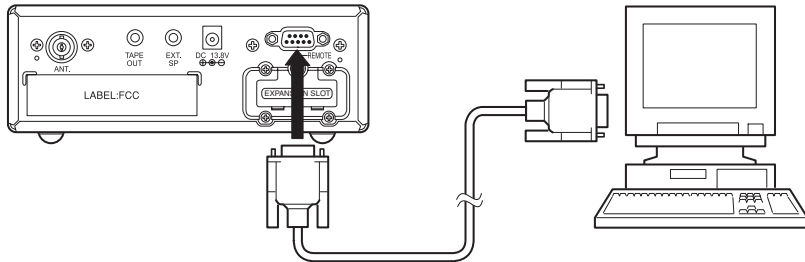

To connect the Scanner to a PC, plug the scanner end of the supplied RS232C cable into the remote port which is on the side of the scanner. Plug the other end of the cable into your PC's serial port.

Start the remote mode and set the scanner's communications speed:

```
3:SYSTEM OPTION → 5:PC CONTROL
```

To use PC control, set the scanner to any setting other than off. You will usually want to set the speed to its highest setting. If you seem to be having communications problems between the scanner and PC, set this setting to a lower value.

Cloning Scanner Settings

You will need to purchase an RS232C null modem adapter/gender changer to connect your scanners together. (These items are available at your local electronics stores.)

To connect the Scanners together, plug the scanner ends of the cables into the scanners, then connect the PC ends of the cables to the null modem adapter/gender changer

Clone all of the programming of one BC796D into another, by selecting:

```
3:SYSTEM OPTION → 6:CLONE
```

on both scanners. Then, on the scanner that has the data you want to transfer, select MASTER and press **E**. On the scanner that you want to transfer the data into, select SLAVE and press **E**. Then, press **SCAN** on both scanner to start the transfer.

Caution: This deletes all data from the unit you select as SLAVE. Make certain that you pick the correct settings for each scanner to prevent data loss.

During transfer both scanners display the following.

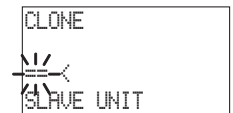
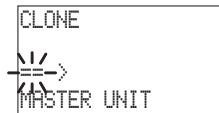

When transfer is complete, the scanners display COMPLETE. Turn both scanners off and then back on to initialize them.

If data transfer is not successful, the following message appears.

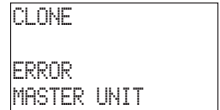

To clear the error, press  . To exit the clone mode, repeatedly press **MENU**.

Care and Maintenance

General Use

- Turn the scanner OFF before disconnecting the power.
- Always write down the programmed frequencies in the event of memory loss.
- If memory is lost, simply reprogram each channel.
The display shows 000.0000 in all channels when there has been a memory loss.
- Always press each button firmly until you hear the entry tone for that key entry, unless you have turned 2:OFF the
3:KEY BEEP in the menu system.

Location

- Do not use the scanner in high-moisture environments such as the kitchen or bathroom.
- Avoid placing the unit in direct sunlight or near heating elements or vents.
- If the scanner receives strong interference or electrical noise, move it or its antenna away from the source of the noise. If possible, a higher elevation, may provide better reception.

Cleaning

- Disconnect the power to the unit before cleaning.
- Clean the outside of the scanner with a mild detergent.
To prevent scratches, do not use abrasive cleaners or solvents. Be careful not to rub the LCD window.
- Do not use excessive amounts of water.

Repairs

- Do not attempt any repair. The scanner contains no user serviceable parts. Contact the Uniden Customer Service Center or take it to a qualified repair technician.

Birdies

- All radios can receive birdies (undesired signals). If your scanner stops during Scan mode and no sound is heard, it may be receiving a birdie. Birdies are internally generated signals inherent in the electronics of the receiver.

Press **L/O** to lockout the channel, and then press **RSM** to resume scanning.

Troubleshooting

If your BC796D is not performing properly, try the following steps.

Problem	Suggestion
Scanner won't work.	<ol style="list-style-type: none"> 1. Check the connections at both ends of the AC Adapter. 2. Turn ON the wall switch of your room. You could be using an outlet controlled by the wall switch. 3. Move the AC Adapter to another wall outlet.
Improper reception.	<ol style="list-style-type: none"> 1. Check the antenna connection. 2. Move the scanner. 3. You may be in a remote area which could require an optional multi-band antenna. Check with your dealer or local electronics store.
Scan won't stop.	<ol style="list-style-type: none"> 1. Adjust squelch threshold - refer to page 19, "Setting the Squelch". 2. Check the antenna connection. 3. Check to see if many of the channels are Locked Out. If so, the scanner has less chance of finding an active channel. 4. Review each channels frequency to see if it is still stored in Memory and is correct. 5. Its possible that none of the programmed frequencies are currently active.
Scan won't start.	<ol style="list-style-type: none"> 1. Press the SCAN key again. 2. Adjust squelch threshold - refer to page 19, "Setting the Squelch". 3. Check to see if all channels are Locked Out.
Weather Scan won't work.	<ol style="list-style-type: none"> 1. Adjust squelch threshold - refer to page 19, "Setting the Squelch". 2. Check the antenna.

If you experience difficulty while in TrunkTracker mode, try the following steps.

Problem	Suggestion
Scanner won't track.	<ol style="list-style-type: none"> 1. Missing the Data Frequency 2. Change to a Type 1 Scanner setup. Review "User Defined Fleet Maps" on page 66.
Scanner won't stop during Scan List mode.	<ol style="list-style-type: none"> 1. No IDs have been programmed. 2. The IDs you have stored are not active.
Scanner will not acquire data channel.	<ol style="list-style-type: none"> 1. Adjust the squelch for Trunking mode. See page 19. 2. Missing the frequency used for the data channel. Check your frequency list.
Missing replies to conversations.	<ol style="list-style-type: none"> 1. Change to a Type 1 scanner setup. Review "User Defined Fleet Maps" on page 66. 2. Try another Preset Fleet Map or Program your own Fleet Map. 3. Check to see that all of the systems frequencies have been entered.
Channel Activity Indicators are flashing but no sound is heard.	<ol style="list-style-type: none"> 1. May be a telephone interconnect call, which are intentionally blocked by your scanner. 2. The ID on your display is not active.
Scanner not tracking an EDACS system properly.	<ol style="list-style-type: none"> 1. Logical channel numbers (frequencies) for the system are not programmed in the correct order. Check frequency resources and reprogram. 2. Not all frequencies for the system are programmed. Check frequency resources.

Problem	Suggestion
APCO P25 CARD NOT INSTALLED appear when the scanner is turned ON.	1. Check to see if the P-25 Card is properly installed.
Neither APCO P25 CARD INSTALLED 9600 SYSTEM nor APCO P25 CARD NOT INSTALLED appear when the scanner is turned ON.	1. Check to see if the P-25 Card Mode is 1:ENABLE or 2:DISABLE in the Menu mode.
Scratchy or robotic sound is heard during communications.	1. Move to a location where the signal strength is strong. 2. Modulation accuracy of transmissions sent can be low.
Digital communication is not heard.	1. Verify the accuracy of the frequencies of the P-25 system you are trying to monitor. 2. You might be in a dead-spot for the P-25 system you are trying to monitor. Check other locations in the area.
DATA sound is heard at the beginning of digital communications.	1. APCO project 25 systems can send data before voice communication. 2. Data sound can be heard when signal strength is weak.
Robotic sound is heard.	1. Check to see if the ENC message appears on the display. The scanner doesn't monitor encrypted voice communications.
When CARD ERROR appears every 10 seconds while you are using P-25 Card.	1. Re-install the P-25 Card.

If you still cannot get satisfactory results while using your scanner or if you want additional information, please call or write the Uniden Parts and Service Division. The address and phone number is listed in the warranty at the end of this manual. If you would like immediate assistance, please call Customer Service at (800)297-1023.

If you have internet access, you can visit scanner.uniden.com for additional information.

Specifications

Certified in accordance with FCC Rules and Regulations Part 15, Subpart C, as of date of manufacture.

Channel:	1000
Banks:	10 (100 channels each)
Service Bands:	12 preprogrammed search bands (including the NOAA Weather Service band)
Frequency Range:	25.0-28.0 MHz Petroleum Prod., CB Class D channels, Business and Forest Products 28.0-29.7 MHz 10 Meter Amateur Band 29.7-50.0 MHz VHF Low Band 50.0-54.0 MHz 6 Meter Amateur Band 54.0-108 MHz VHF TV, FM broadcast, Intersystem and Astronomy 108-137 MHz Aircraft Band 137-144 MHz Military Land Mobile 144-148 MHz 2 Meter Amateur Band 148-174 MHz VHF High Band 174-406 MHz VHF TV, 1.25 Meter Amateur Band, UHF Aircraft Band 406-420 MHz Federal Government 420-450 MHz 70 cm Amateur Band 450-470 MHz UHF Standard Band 470-512 MHz UHF TV Band 806-956 MHz 800 Band 1240-1300 MHz 25cm Amateur Band
Operating Temperature:	-20 °C to +60 °C (-4 °F to +140)
Scan Rate:	100 channels per second (conventional mode)
Search Rate:	100 steps per second (Normal Search) 300 steps per second (Turbo Search)
Audio Output:	Maximum 3.0W (2.3W normal @ 10% THD)
Internal Speaker:	8 ohms (56 mm outer diameter)
Power Requirements:	AD580U AC Adapter (13.8V DC, 700mA)
Antenna:	Telescopic Antenna (included)
Antenna Jack:	BNC type
External Jacks:	External Speaker (EXT.SP.) (3.5 mm) DC 13.8 V Power Jack, (center is positive) Remote Control (REMOTE) Jack (DB-9) Tape Recorder Out (TAPE OUT) Jack (3.5 mm) Digital Card Slot
Size:	6-15/16 in. (W) x 6-9/16 in. (D) x 2-3/8 in. (H) 176.5mm (W) x 167mm (D) x 61mm (H)
Weight:	1.44 kg (50.8 oz.)

Features and specifications are all subject to change without notice.

Glossary of Terms

Alpha tag - This term refers to an alphanumeric text tag that you can enter to describe the individual frequencies that you have programmed. Rather than having to associate a specific frequency to the individuals that are using it, you can enter the actual name of the group. This will eliminate the need for memorizing the group's frequency.

Attenuator - This scanner comes with a feature to attenuate or reduce the signal strength. The built-in attenuator can be turned on specific frequencies to prevent strong signals from overloading the scanner input, possibly damaging the scanner or missing other transmissions due to the repeated stopping on the stronger signal.

Clone - This term identifies the ability to set up a duplicate scanner. This function allows you to clone all the programming information, including frequencies, talkgroups and alpha tags as well as bank settings and other parameters from one BC796D to another or BC296D.

Control Channel - This is the frequency within a trunking system - that runs the system. On Control Channels (sometimes called Data Channels) you will hear a buzz saw sound. For the most part, it is the sound of the system's central computer directing talkgroups to particular voice (working) frequencies within the system.

CTCSS - (Continuous Tone Controlled Squelch System) refers to a system where the radio receivers are equipped with tone responsive devices which allow audio signals to appear at the audio output, select voice processing such as scrambling or control repeater functions only when a carrier modulated with a specific tone is received. This method may be used to restrict access to the repeater or receiver, or reduce interference where several stations with output frequencies in close proximity of each other make it difficult to hear the conversation you are interested in. With CTCSS squelching, you can eliminate the possibility of hearing unwanted conversations by selecting one of the 38 standard subaudible tones. You will only hear those transmissions that have been programmed on specific frequencies with the specific subaudible tone that you have selected.

DCS - (Digital Controlled Squelch) refers to a system where the radio receivers are equipped with data burst responsive devices which allow audio signals to appear at the audio output, select voice processing such as scrambling or control repeater functions only when a carrier modulated with specific data burst is received. This method may be used to restrict access to the repeater or receiver, or reduce interference where several stations with output frequencies in close proximity of each other make it difficult to hear the conversation you are interested in. With DCS squelching, you can eliminate the possibility of hearing unwanted conversations by selecting one of the 104 standard data burst subaudible tones. You will only hear those transmissions that have been programmed on specific frequencies with the specific subaudible tone that you have selected.

Enter Lock - This is the term used for locking the keypad. This prevents accidental re-programming of channels and talkgroups entered into memory. The default setting is OFF.

When ENTER LOCK is enabled, the following functions will be disabled:

- Enter or modify the Memory Channel frequency
- Enter or modify the Tone information

- Enter or modify the Trunking ID. (this can be modified through the menu screen.)

FIPS Codes - For the purpose of broadcasting weather information, the NWS (National Weather Service) has divided the United States into regions by state and county (or parish, where applicable) then assigned a 6 digit FIPS code to identify each county or parish. The first digit represents the county subdivision, the next two represents the state, and the last three digits represent the county or parish. Your scanner can receive all SAME alert signals broadcasted within about a 50-mile radius of where you install it. So if you only want to hear the counties that are nearest to your area, you can choose specifically the FIPS code of areas that you want. This lets you avoid hearing warnings that apply to an area within a 50-mile radius but not necessarily in your county or parish.

I-Call - Most communications within a trunked system are group calls where one unit (such as a dispatcher) communicates with all the units within her group (all the patrol vehicles on the east side of town, for example).

The units within this group comprise what is typically known as a talkgroup. There are some communications which are direct unit-to-unit conversations where one individual converses with another individual. The call is initiated by a radio and is directed to another single radio. Within the system, no one outside of these two users hears the conversation. This call is referred to as I-Call.

Key Beep - This is another term for the tone you hear as a keypad acknowledgement beep. The default setting is on.

If you have turned the Key Beep off, you now have a silent keypad. You will not hear a tone each time you press a key.

NWR S.A.M.E. Weather Alert - In 1994, the National Oceanic and Atmospheric Administration (NOAA) began broadcasting coded signals called FIPS (Federal Information Processing System) codes along with the standard weather broadcasts for stations in your area. These codes identify an emergency and the specific geographic area (such as your county) affected by the emergency. The scanner was developed with SAME (Specific Area Messaging Encoding) technology.

This allows you scanner to receive, interpret, and display the information about the codes so you can determine if the emergency might affect you area. Each FIPS code identifies a specific geographic area (defined by the National Weather Service) so your scanner sounds an alert only when a weather emergency is declared in those locations.

This helps you more efficiently track the weather conditions in and around your area.

PC Control - This term is associated with the ability to program frequencies and other useful information via a computer by means of third party software. You can change the transfer speed on the scanner needed to be compatible with your PC. (See page 55)

Scan List - When you designate a bank to be a trunking bank, your scanner sets up 10 Scan Lists, which are simply list of your favorite IDs. Each list can contain up to 10 IDs, so you can store a total of 100 IDs for each trunk bank. These lists are designed to help you organize the trunking system users into categories.

Screen Mask - Screen Mask reduces the amount of information that appears on the display. Alpha tags that you have set for a channel along with a few function icons will appear only on the display. This mode is particularly useful in public safety vehicles where that are already overloaded with information. Screen Mask does not work in Search mode.

Status Bit - This term refers to Motorola Type II systems. There is a method by which special types of communications utilize unique talk group numbers. For example, if all emergency calls are set to occur on a specific talk group number then you will not miss the transmission even if you have not programmed all the talk group numbers. With the Status Bit on and you have programmed the unique number, then you don't have to worry what the rest of the groups numbers are. The topic of interest will be picked up.

Talkgroup - A group of users within a trunked system that communicates with one another.

Appendix

Preset Fleet Maps

Preset Map 1

Block	Size Code
0	SIZE CODE 11
1	SIZE CODE 11
2	SIZE CODE 11
3	SIZE CODE 11
4	SIZE CODE 11
5	SIZE CODE 11
6	SIZE CODE 11
7	SIZE CODE 11

Preset Map 2

Block	Size Code
0	SIZE CODE 4
1	SIZE CODE 4
2	SIZE CODE 4
3	SIZE CODE 4
4	SIZE CODE 4
5	SIZE CODE 4
6	SIZE CODE 4
7	SIZE CODE 4

Preset Map 3

Block	Size Code
0	SIZE CODE 4
1	SIZE CODE 4
2	SIZE CODE 4
3	SIZE CODE 4
4	SIZE CODE 4
5	SIZE CODE 4
6	SIZE CODE 12
7	(SIZE CODE 12)

Preset Map 4

Block	Size Code
0	SIZE CODE 12
1	(SIZE CODE 12)
2	SIZE CODE 4
3	SIZE CODE 4
4	SIZE CODE 4
5	SIZE CODE 4
6	SIZE CODE 4
7	SIZE CODE 4

Preset Map 5

Block	Size Code
0	SIZE CODE 4
1	SIZE CODE 4
2	SIZE CODE 12
3	(SIZE CODE 12)
4	SIZE CODE 4
5	SIZE CODE 4
6	SIZE CODE 4
7	SIZE CODE 4

Preset Map 6

Block	Size Code
0	SIZE CODE 3
1	SIZE CODE 10
2	SIZE CODE 4
3	SIZE CODE 4
4	SIZE CODE 12
5	(SIZE CODE 12)
6	SIZE CODE 12
7	(SIZE CODE 12)

Preset Map 7

Block	Size Code
0	SIZE CODE 10
1	SIZE CODE 10
2	SIZE CODE 11
3	SIZE CODE 4
4	SIZE CODE 4
5	SIZE CODE 4
6	SIZE CODE 4
7	SIZE CODE 4

Preset Map 8

Block	Size Code
0	SIZE CODE 1
1	SIZE CODE 1
2	SIZE CODE 2
3	SIZE CODE 2
4	SIZE CODE 3
5	SIZE CODE 3
6	SIZE CODE 4
7	SIZE CODE 4

Preset Map 9

Block	Size Code
0	SIZE CODE 4
1	SIZE CODE 4
2	SIZE CODE 0
3	SIZE CODE 0
4	SIZE CODE 0
5	SIZE CODE 0
6	SIZE CODE 0
7	SIZE CODE 0

Preset Map 10

Block	Size Code
0	SIZE CODE 0
1	SIZE CODE 0
2	SIZE CODE 0
3	SIZE CODE 0
4	SIZE CODE 0
5	SIZE CODE 0
6	SIZE CODE 4
7	SIZE CODE 4

Preset Map 11

Block	Size Code
0	SIZE CODE 4
1	SIZE CODE 0
2	SIZE CODE 0
3	SIZE CODE 0
4	SIZE CODE 0
5	SIZE CODE 0
6	SIZE CODE 0
7	SIZE CODE 0

Preset Map 12

Block	Size Code
0	SIZE CODE 0
1	SIZE CODE 0
2	SIZE CODE 0
3	SIZE CODE 0
4	SIZE CODE 0
5	SIZE CODE 0
6	SIZE CODE 0
7	SIZE CODE 4

Preset Map 13

Block	Size Code
0	SIZE CODE 3
1	SIZE CODE 3
2	SIZE CODE 11
3	SIZE CODE 4
4	SIZE CODE 4
5	SIZE CODE 0
6	SIZE CODE 0
7	SIZE CODE 0

Preset Map 14

Block	Size Code
0	SIZE CODE 4
1	SIZE CODE 3
2	SIZE CODE 10
3	SIZE CODE 4
4	SIZE CODE 4
5	SIZE CODE 4
6	SIZE CODE 12
7	(SIZE CODE 12)

Preset Map 15

Block	Size Code
0	SIZE CODE 4
1	SIZE CODE 4
2	SIZE CODE 4
3	SIZE CODE 11
4	SIZE CODE 11
5	SIZE CODE 0
6	SIZE CODE 12
7	(SIZE CODE 12)

Preset Map 16

Block	Size Code
0	SIZE CODE 3
1	SIZE CODE 10
2	SIZE CODE 10
3	SIZE CODE 11
4	SIZE CODE 0
5	SIZE CODE 0
6	SIZE CODE 12
7	(SIZE CODE 12)

User Defined Fleet Maps

Type I Programming Information

When a Type I system is designed, the address information for all the IDs are divided into 8 equal sized blocks. When you program your scanner to track a Type I system, you must select a size code for each of these blocks. When you have assigned a size code to all 8 blocks, you have defined the Fleet Map for the system you're tracking. Each size code determines the number of Fleets, Subfleets, and IDs each block will have. For example, a size code of "4" has one Fleet, which is divided into 16 separate Subfleets, and it has a total of 512 individual IDs.

When a block is assigned a size code, the Fleet or Fleets created within the block are assigned a Type I ID. The way these IDs display on your scanner depends on the block number and the blocks size code. When a Type I ID displays, the left most digit represents the block which contains the ID. The next two or three digits identify which Fleet is active, and the last digit(s) identifies the Subfleet.

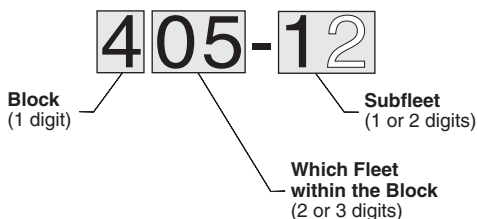

The details concerning how the size codes are selected by a Type I system designer are highly dependent on the specific needs of the systems users. Some organizations may want many subfleets with only a few radios each, while another organization may want only a few subfleets with many radios each. Your task is to program your fleet map with the same size code assignments as the trunked system. If you do this accurately, you'll track all the Fleet-Subfleet combinations used by the system. In other words, you'll hear complete communications while monitoring a trunked system.

If you don't already know the size codes used, you'll have to guess at them. But since you don't have to figure out all the blocks at once, this isn't as hard as it seems. Select a size code for a block, and then press **SCAN**. Now listen to the communications. If you decide you are receiving most of the replies to the conversations with IDs assigned to the block you just programmed, then you've probably selected the right size code and can work on the next block of the map.

Finally, for most public safety systems there are some size codes which are more common. SIZE CODE 3 and SIZE CODE 4 are probably the most common, followed by SIZE CODE 10, SIZE CODE 11, and SIZE CODE 12.

Fleet Map Size Codes

Size	Fleets	Subfleets	IDs	Blocks Used
0	Reserves block for Type II IDs			+
1	128	4	16	1
2	16	8	64	1
3	8	8	128	1
4	1	16	512	1
5	64	4	32	1
6	32	8	32	1
7	32	4	64	1
8	16	4	128	1
9	8	4	256	1
10	4	8	256	1
11	2	16	256	1
12	1	16	1024	2
13	1	16	2048	4
14	1	16	4096	8

Size Code Restrictions

If you select SIZE CODE 12, 13, or 14, there are some restrictions as to which blocks can be used for these codes.

- SIZE CODE 12 can only be assigned to Blocks 0, 2, 4, or 6.
- SIZE CODE 13 can only be assigned to Blocks 0 and 4.
- SIZE CODE 14 can only be assigned to Block 0.

Since these SIZE CODES require multiple blocks, you will be prompted for the next available block when programming a Fleet Map. For example, if you assign Block 0 as an SIZE CODE 12, you will be prompted for Block 2, the next block available, instead of Block 1. And if you assign Block 0 as SIZE CODE 14, you would not see another prompt because all available blocks have been used.

NWR-SAME EVENT CODE

Event Code	Standard	Event Level (Siren Type)				LCD Display
		Warning	Watch	Statement	Test	
Emergency Action Notification	EAN	0				EMG NOTIFY
Emergency Action Termination	EAT	0				EMG TERMINATE
National Information Center	NIC	0				NATIONAL INFO
Tornado Warning #	TOW _(or TOR)	0				TORNADO
Service Thunderstorm Warning #	SVW _(or SVR)	0				THUNDERSTORM
Flash Flood Warning	FFW	0				FLASH FLOOD
Flash Warning	FLW	0				FLOOD
Winter Storm Warning	WSW	0				WINTER STORM
Blizzard Warning	BZW	0				BLIZZARD
High Wind/ Dust Storm Warning	HWW	0				HIGH WIND
Radiological Hazard Warning	RHW	0				RADIOLOGICAL
Civil Danger Warning	CDW	0				CIVIL DANGER
Local Area Emergency	LAE	0				LOCAL EMG
Hazardous Material Warning	HMW	0				HAZARDOUS
Civil Emergency Message	CEM	0				CIVIL EMG
Immediate Evacuation Warning	IEW	0				EVACUATION
Immediate Evacuation Notice	EVI	0				EVACUATE NOTE
Law Enforcement Warning	LEW	0				LAW ENFORCEMENT
Fire Warning	FRW	0				FIRE
Hurricane/Tropical Storm Warning	HUW	0				HURRICANE
Tsunami Warning	TSW	0				TSUNAMI
Coastal Flood Warning	CFW	0				COASTAL FLOOD
Special Marine Warning	SMW	0				SPECIAL MARINE
Avalanche Warning	AWW	0				AVALANCHE
Volcano Warning	VOW	0				VOLCANO
Shelter In Place Warning	SPW	0				SHELTER
Civil Danger Watch	CDA		0			CIVIL DANGER
Radiological Hazard Watch	RHA		0			RADIOLOGICAL
Hazardous Material Watch	HMA		0			HAZARDOUS
Winter Storm Watch	WSA		0			WINTER STORM
High Wind/ Dust Storm Watch	HWA		0			HIGH WIND
Tornado Watch	TOA		0			TORNADO
Severe Thunderstorm Watch	SVA		0			THUNDERSTORM
Flash Flood Watch	FFA		0			FLASH FLOOD
Flood Watch	FLA		0			FLOOD
Hurricane/ Tropical Storm Watch	HUA		0			HURRICANE
Tsunami Watch	TSA		0			TSUNAMI
Coastal Flood Watch	CFA		0			COASTAL FLOOD
Avalanche Watch	AVA		0			AVALANCHE
Volcano Watch	VOA		0			VOLCANO

Event Code	Standard	Event Level (Siren Type)				LCD Display
		Warning	Watch	Statement	Test	
Severe Weather Statement	SVS			0		SEVERE WX
Special Weather Statement	SPS			0		SPECIAL WX
Flash Flood Statement	FFS			0		FLASH FLOOD
Flood Statement	FLS			0		FLOOD
Hurricane Statement	HLS			0		HURRICANE
National Periodic Test	NPT				0	NATION PERIOD
Required Monthly Test	RMT				0	MONTHLY
Required Weekly Test	RWT				0	WEEKLY
System Demonstration/ Practice	DMO				Note	SYSTEM DEMO
National Hazard Warning	NHW	0				NATION HAZARD
Unknown Emergency Tune TV	**E	0				UNKNOWN TV
Unknown Warning Tune TV	**W	0				UNKNOWN TV
Unknown Watch Tune TV	**A		0			UNKNOWN TV
Unknown Statement Tune TV	**S			0		UNKNOWN TV
Administrative Message	ADR			0		ADMIN MESSAGE
Child Abduction Emergency	CAE	0				CHILD EMERGENCY
Dust Storm Warning	DSW	0				DUST STORM
Earthquake Warning	EQW	0				EARTHQUAKE
Network Message Notification	NMN			0		NETWORK MESSAGE
911 telephone Outage Emergency	TOE	0				911 PHONE OUTAGE
Nuclear Power Plant Warning	NUW	0				NUCLEAR PLANT
Tropical Storm Warning	TRW	0				TROPICAL STORM
Tropical Storm Watch	TRA		0			TROPICAL STORM
Dust Storm Watch	DSA		0			DUST STORM
Earthquake Watch	EQA		0			EATHQUAKE
Missing Child Statement	MIS			0		MISSING CHILD
Nuclear Power Plant Test Messag	NPM				0	NUCLEAR PLANT
Nuclear Power Plant Warning	NPW	0				NUCLEAR PLANT
Nuclear Power Plant Warning	NPP	0				NUCLEAR PLANT
School Closing Statement	SCS			0		SCHOOL CLOSING
Dam Break Warning	DBW	0				DAM BREAK

Note: Demo alerts are displayed but no audible alert is generated.

REVERSE LIST

Range	Offset	Range	Offset
29.520 - 29.580	+0.1 MHz	445.000 - 449.9875	-5 MHz
29.620 - 29.680	-0.1 MHz	450.000 - 454.9875	+5 MHz
52.010 - 52.990	+1 MHz	455.000 - 459.9875	-5 MHz
53.010 - 53.990	-1 MHz	460.000 - 464.9875	+5 MHz
143.750	+4.375 MHz	465.000 - 469.9875	-5 MHz
143.900	+4.25 MHz	470.000 - 472.9875	+3 MHz
144.510 - 144.890	+0.6 MHz	473.000 - 475.9875	-3 MHz
145.110 - 145.490	-0.6 MHz	476.000 - 478.9875	+3 MHz
146.010 - 146.385	+0.6 MHz	479.000 - 481.9875	-3 MHz
146.415 - 146.505	+1 MHz	482.000 - 484.9875	+3 MHz
146.595	+1 MHz	485.000 - 487.9875	-3 MHz
146.610 - 146.985	-0.6 MHz	488.000 - 490.9875	+3 MHz
147.000 - 147.390	+0.6 MHz	491.000 - 493.9875	-3 MHz
147.415 - 147.505	-1 MHz	494.000 - 496.9875	+3 MHz
147.595	-1 MHz	497.000 - 499.9875	-3 MHz
147.600 - 147.990	-0.6 MHz	500.000 - 502.9875	+3 MHz
148.125	-4.375 MHz	503.000 - 505.9875	-3 MHz
148.150	-4.25 MHz	506.000 - 508.9875	+3 MHz
222.120 - 223.380	+1.6 MHz	509.000 - 511.9875	-3 MHz
223.720 - 224.980	-1.6 MHz	806.000 - 823.9875	+45 MHz
420.000 - 424.9875	+5 MHz	851.000 - 868.9875	-45 MHz
425.000 - 429.9875	-5 MHz	896.000 - 901.000	+39 MHz
440.000 - 444.9875	+5 MHz	935.000 - 940.000	-39 MHz

The reverse frequency for trunked systems is determined by the trunking system settings and can vary from the standard band plans.

CTCSS Frequency List (Hz)

67.0	71.9	74.4	77.0	79.7	82.5	85.4	88.5
91.5	94.8	97.4	100.0	103.5	107.2	110.9	114.8
118.8	123.0	127.3	131.8	136.5	141.3	146.2	151.4
156.7	162.2	167.9	173.8	179.9	186.2	192.8	203.5
210.7	218.1	225.7	233.6	241.8	250.3		

DCS Tone Code

023	025	026	031	032	036	043	047
051	053	054	065	071	072	073	074
114	115	116	122	125	131	132	134
143	145	152	155	156	162	165	172
174	205	212	223	225	226	243	244
245	246	251	252	255	261	263	265
266	271	274	306	311	315	325	331
332	343	346	351	356	364	365	371
411	412	413	423	431	432	445	446
452	454	455	462	464	465	466	503
506	516	523	526	532	546	565	606
612	624	627	631	632	654	662	664
703	712	723	731	732	734	743	754

BC796D Flow Charts

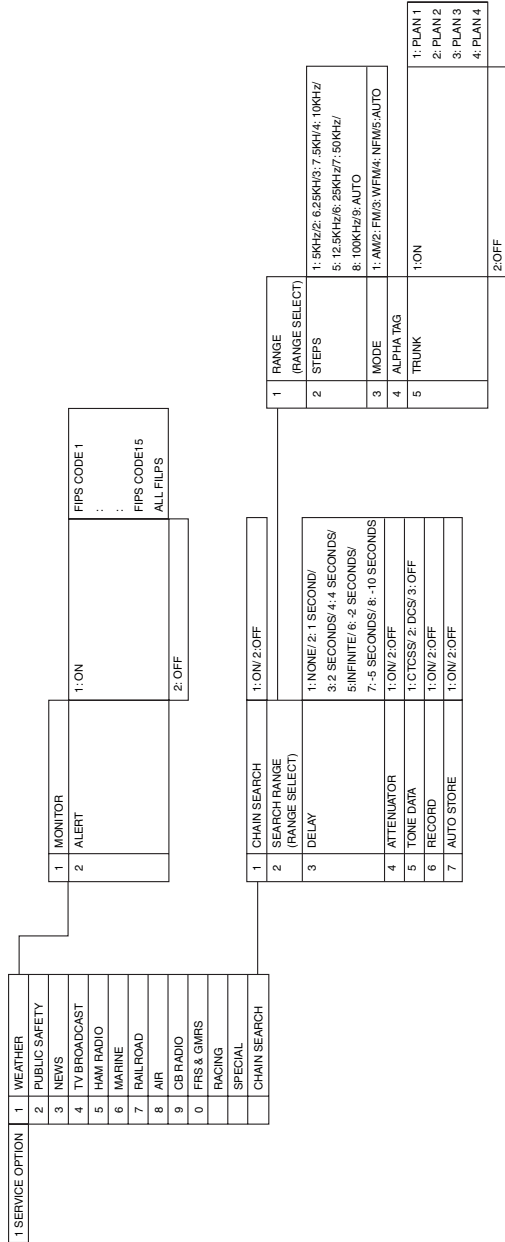

3. SYSTEM OPTION	1	DIMMER	1: HIGH / 2: MEDIUM / 3: OFF
	2	SCREEN MASK	1: ON / 2: OFF
	3	KEY BEEP	1: ON / 2: OFF
	4	ENTER LOCK	1: ON / 2: OFF
	5	PC CONTROL	1: 2400 bps / 2: 4800 bps / 3: 9600 bps / 4: 19200 bps / 5: 38400 bps / 6: 57600 bps / 7: OFF
	6	CLONE	MASTER / SLAVE
	7	DATA SKIP	1: ON / 2: OFF
	8	SO MODE	1: CSQ / 2: TONE SQ / 3: TONE SEARCH
	9	BANK TAG (SELECT BANK)	
	0	P-25 CARD	1: ENABLE / 2: DISABLE

One Year Limited Warranty

Important: Evidence of original purchase is required for warranty service.

WARRANTOR: UNIDEN AMERICA CORPORATION (Uniden)

ELEMENTS OF WARRANTY: Uniden warrants, for one year, to the original retail owner, this Uniden product to be free from defects in materials and craftsmanship with only the limitations or exclusions set out below.

WARRANTY DURATION: This warranty to the original user shall terminate and be of no further effect 12 months after the date of original retail sale. The warranty is invalid if the Product is (A) damaged or not maintained as reasonable or necessary, (B) modified, altered, or used as part of any conversion kits, subassemblies, or any configurations not sold by Uniden, (C) improperly installed, (D) serviced or repaired by someone other than an authorized Uniden service center for a defect or malfunction covered by this warranty, (E) used in any conjunction with equipment or parts or as part of any system not manufactured by Uniden, or (F) installed or programmed by anyone other than as detailed by the owners manual for this product.

STATEMENT OF REMEDY: In the event that the product does not conform to this warranty at any time while this warranty is in effect, warrantor will either, at its option, repair or replace the defective unit and return it to you without charge for parts, service, or any other cost (except shipping and handling) incurred by warrantor or its representatives in connection with the performance of this warranty. Warrantor, at its option, may replace the unit with a new or refurbished unit. THE LIMITED WARRANTY SET FORTH ABOVE IS THE SOLE AND ENTIRE WARRANTY PERTAINING TO THE PRODUCT AND IS IN LIEU OF AND EXCLUDES ALL OTHER WARRANTIES OF ANY NATURE WHATSOEVER, WHETHER EXPRESS, IMPLIED OR ARISING BY OPERATION OF LAW INCLUDING, BUT NOT LIMITED TO ANY IMPLIED WARRANTIES OF MERCHANTABILITY OR FITNESS FOR A PARTICULAR PURPOSE. THIS WARRANTY DOES NOT COVER OR PROVIDE FOR THE REIMBURSEMENT OR PAYMENT OF INCIDENTAL OR CONSEQUENTIAL DAMAGES. Some states do not allow this exclusion or limitation of incidental or consequential damages so the above limitation or exclusion may not apply to you.

LEGAL REMEDIES: This warranty gives you specific legal rights, and you may also have other rights which vary from state to state. This warranty is void outside the United States of America.

PROCEDURE FOR OBTAINING PERFORMANCE OF WARRANTY: If, after following the instructions in the owners manual you are certain that the product is defective, pack the Product carefully (preferably in its original packaging). The product should include all parts and accessories originally packaged with the Product. Include evidence of original purchase and a note describing the defect that has caused you to return it. The Product should be shipped freight prepaid, by traceable means, to warrantor at:

UNIDEN AMERICA CORPORATION
Parts and Service Division
4700 Amon Carter Boulevard
Fort Worth, TX 76155

(800) 554-3988, 7 a.m. to 5 p.m. Central Time, Monday through Friday

Memo

Memo

Memo

**THANK YOU FOR
PURCHASING A
UNIDEN PRODUCT!**

A World Without Wires

Uniden®

May be covered under one or more of the following U.S. patents:

4,687,558	4,687,562	4,896,815	4,902,274	4,947,496	5,074,048
5,199,558	5,429,269	5,829,505	5,838,890	5,948,290	6,165,823
6,477,869	6,483,684	7,000,290	7,398,832	7,771,271	8,174,888
8,077,070	8,080,420	8,800,223	8,940,424	9,716,882	9,996,422
9,981,946	9,981,922	9,912,158	9,925,740	9,974,973	9,994,270
9,999,821					

™ U.S. Patent Number 4,891,262 is licensed from Day Electronics, Inc.

Contains additional foreign articles.

Custom manufactured in China.

©2003 Uniden America Corporation, Fort Worth, TX
All rights reserved.